

Network Working Group
Request for Comments: 4666
Obsoletes: 3332
Category: Standards Track

K. Morneault, Ed.
Cisco Systems
J. Pastor-Balbas, Ed.
Ericsson
September 2006

Signaling System 7 (SS7) Message Transfer Part 3 (MTP3) -
User Adaptation Layer (M3UA)

Status of This Memo

This document specifies an Internet standards track protocol for the Internet community, and requests discussion and suggestions for improvements. Please refer to the current edition of the "Internet Official Protocol Standards" (STD 1) for the standardization state and status of this protocol. Distribution of this memo is unlimited.

Copyright Notice

Copyright (C) The Internet Society (2006).

Abstract

This memo defines a protocol for supporting the transport of any SS7 MTP3-User signalling (e.g., ISUP and SCCP messages) over IP using the services of the Stream Control Transmission Protocol. Also, provision is made for protocol elements that enable a seamless operation of the MTP3-User peers in the SS7 and IP domains. This protocol would be used between a Signalling Gateway (SG) and a Media Gateway Controller (MGC) or IP-resident Database, or between two IP-based applications. It is assumed that the SG receives SS7 signalling over a standard SS7 interface using the SS7 Message Transfer Part (MTP) to provide transport. This document obsoletes RFC 3332.

Table of Contents

1. Introduction	6
1.1. Scope	6
1.2. Terminology	6
1.3. M3UA Overview	9
1.3.1. Protocol Architecture	9
1.3.2. Services Provided by the M3UA Layer	10
1.3.2.1. Support for the Transport of MTP3-User Messages	10
1.3.2.2. Native Management Functions	11
1.3.2.3. Interworking with MTP3 Network Management Functions	11
1.3.2.4. Support for the Management of SCTP Associations between the	11
1.3.2.5. Support for the Management of Connections to Multiple SGPs	12
1.4. Functional Areas	12
1.4.1. Signalling Point Code Representation	12
1.4.2. Routing Contexts and Routing Keys	14
1.4.2.1. Overview	14
1.4.2.2. Routing Key Limitations	15
1.4.2.3. Managing Routing Contexts and Routing Keys	15
1.4.2.4. Message Distribution at the SGP	15
1.4.2.5. Message Distribution at the ASP	16
1.4.3. SS7 and M3UA Interworking	16
1.4.3.1. Signalling Gateway SS7 Layers	16
1.4.3.2. SS7 and M3UA Interworking at the SG	17
1.4.3.3. Application Server	17
1.4.3.4. IPSP Considerations	18
1.4.4. Redundancy Models	18
1.4.4.1. Application Server Redundancy	18
1.4.5. Flow Control	18
1.4.6. Congestion Management	19
1.4.7. SCTP Stream Mapping	19
1.4.8. SCTP Client/Server Model	19
1.5. Sample Configuration	20
1.5.1. Example 1: ISUP Message Transport	20
1.5.2. Example 2: SCCP Transport between IPSPs	21
1.5.3. Example 3: SGP Resident SCCP Layer, with Remote ASP	22
1.6. Definition of M3UA Boundaries	23
1.6.1. Definition of the Boundary between M3UA and an MTP3-User	23
1.6.2. Definition of the Boundary between M3UA and SCTP ...	23
1.6.3. Definition of the Boundary between M3UA and Layer Management	24

2. Conventions	27
3. M3UA Protocol Elements	28
3.1. Common Message Header	28
3.1.1. M3UA Protocol Version: 8 bits (unsigned integer) ...	28
3.1.2. Message Classes and Types	28
3.1.3. Reserved: 8 Bits	30
3.1.4. Message Length: 32-Bits (Unsigned Integer)	30
3.2. Variable-Length Parameter Format	30
3.3. Transfer Messages	33
3.3.1. Payload Data Message (DATA)	33
3.4. SS7 Signalling Network Management (SSNM) Messages	36
3.4.1. Destination Unavailable (DUNA)	36
3.4.2. Destination Available (DAVA)	39
3.4.3. Destination State Audit (DAUD)	40
3.4.4. Signalling Congestion (SCON)	40
3.4.5. Destination User Part Unavailable (DUPU)	43
3.4.6. Destination Restricted (DRST)	45
3.5. ASP State Maintenance (ASPSM) Messages	45
3.5.1. ASP Up	45
3.5.2. ASP Up Acknowledgement (ASP Up Ack)	46
3.5.3. ASP Down	47
3.5.4. ASP Down Acknowledgement (ASP Down Ack)	48
3.5.5. Heartbeat (BEAT)	48
3.5.6. Heartbeat Acknowledgement (BEAT Ack)	49
3.6. Routing Key Management (RKM) Messages [Optional]	49
3.6.1. Registration Request (REG REQ)	49
3.6.2. Registration Response (REG RSP)	54
3.6.3. Deregistration Request (DEREG REQ)	56
3.6.4. Deregistration Response (DEREG RSP)	57
3.7. ASP Traffic Maintenance (ASPTM) Messages	59
3.7.1. ASP Active	59
3.7.2. ASP Active Acknowledgement (ASP Active Ack)	60
3.7.3. ASP Inactive	61
3.7.4. ASP Inactive Acknowledgement (ASP Inactive Ack) ...	62
3.8. Management (MGMT) Messages	63
3.8.1. Error	63
3.8.2. Notify	67
4. Procedures	70
4.1. Procedures to Support the M3UA-User	70
4.1.1. Receipt of Primitives from the M3UA-User	70
4.2. Receipt of Primitives from the Layer Management	71
4.2.1. Receipt of M3UA Peer Management Messages	72
4.3. AS and ASP/IPSP State Maintenance	73
4.3.1. ASP/IPSP States	74
4.3.2. AS States	76
4.3.3. M3UA Management Procedures for Primitives	78
4.3.4. ASPM Procedures for Peer-to-Peer Messages	79
4.3.4.1. ASP Up Procedures	79

4.3.4.2.	ASP-Down Procedures	81
4.3.4.3.	ASP Active Procedures	82
4.3.4.4.	ASP Inactive Procedures	86
4.3.4.5.	Notify Procedures	88
4.3.4.6.	Heartbeat Procedures	89
4.4.	Routing Key Management Procedures [Optional]	90
4.4.1.	Registration	90
4.4.2.	Deregistration	92
4.4.3.	IPSP Considerations (REG/DEREG)	93
4.5.	Procedures to Support the Availability or Congestion Status of SS7 Destination	93
4.5.1.	At an SGP	93
4.5.2.	At an ASP	94
4.5.2.1.	Single SG Configurations	94
4.5.2.2.	Multiple SG Configurations	94
4.5.3.	ASP Auditing	94
4.6.	MTP3 Restart	96
4.7.	NIF Not Available	97
4.8.	M3UA Version Control	97
4.9.	M3UA Termination	97
5.	Examples of M3UA Procedures	98
5.1.	Establishment of Association and Traffic between SGPs and ASPs	98
5.1.1.	Single ASP in an Application Server ("1+0" sparing), No Registration	98
5.1.1.1.	Single ASP in an Application Server ("1+0" Sparing), No Registration ...	98
5.1.1.2.	Single ASP in Application Server ("1+0" Sparing), Dynamic Registration	99
5.1.1.3.	Single ASP in Multiple Application Servers (Each with "1+0" Sparing), Dynamic Registration (Case 1 - Multiple Registration Requests)	100
5.1.1.4.	Single ASP in Multiple Application Servers (each with "1+0" sparing), Dynamic Registration (Case 2 - Single Registration Request)	101
5.1.2.	Two ASPs in Application Server ("1+1" Sparing) ...	102
5.1.3.	Two ASPs in an Application Server ("1+1" Sparing, Loadsharing Case)	103
5.1.4.	Three ASPs in an Application Server ("n+k" Sparing, Loadsharing Case)	104
5.2.	ASP Traffic Failover Examples	105
5.2.1.	1+1 Sparing, Withdrawal of ASP, Backup Override ...	105
5.2.2.	1+1 Sparing, Backup Override	105
5.2.3.	n+k Sparing, Loadsharing Case, Withdrawal of ASP ..	106
5.3.	Normal Withdrawal of an ASP from an Application Server ...	106
5.4.	Auditing Examples	107

5.4.1.	SG State: Uncongested/Available	107
5.4.2.	SG State: Congested (Congestion Level=2) / Available	107
5.4.3.	SG State: Unknown/Available	107
5.4.4.	SG State: Unavailable	108
5.5.	M3UA/MTP3-User Boundary Examples	108
5.5.1.	At an ASP	108
5.5.1.1.	Support for MTP-TRANSFER Primitives at the ASP	108
5.5.2.	At an SGP	109
5.5.2.1.	Support for MTP-TRANSFER Request Primitive at the SGP	109
5.5.2.2.	Support for MTP-TRANSFER Indication Primitive at the SGP	110
5.5.2.3.	Support for MTP-PAUSE, MTP-RESUME, MTP-STATUS Indication Primitives	110
5.6.	Examples for IPSP Communication	112
5.6.1.	Single Exchange	112
5.6.2.	Double Exchange	113
6.	Security Considerations	113
7.	IANA Considerations	114
7.1.	SCTP Payload Protocol Identifier	114
7.2.	M3UA Port Number	114
7.3.	M3UA Protocol Extensions	114
7.3.1.	IETF-Defined Message Classes	115
7.3.2.	IETF Defined Message Types	115
7.3.3.	IETF-Defined Parameter Extension	115
8.	Acknowledgements	115
9.	Document Contributors	116
10.	References	116
10.1.	Normative References	116
10.2.	Informative References	117
Appendix A	119
A.1.	Signalling Network Architecture	119
A.2.	Redundancy Models	121
A.2.1.	Application Server Redundancy	121
A.2.2.	Signalling Gateway Redundancy	122

1. Introduction

This memo defines a protocol for supporting the transport of any SS7 MTP3-User signalling (e.g., ISUP and SCCP messages) over IP using the services of the Stream Control Transmission Protocol [18]. Also, provision is made for protocol elements that enable a seamless operation of the MTP3-User peers in the SS7 and IP domains. This protocol would be used between a Signalling Gateway (SG) and a Media Gateway Controller (MGC) or IP-resident Database [12], or between two IP-based applications.

1.1. Scope

There is a need for Switched Circuit Network (SCN) signalling protocol delivery from an SS7 Signalling Gateway (SG) to a Media Gateway Controller (MGC) or IP-resident Database as described in the Framework Architecture for Signalling Transport [12]. The delivery mechanism should meet the following criteria:

- * Support for the transfer of all SS7 MTP3-User Part messages (e.g., ISUP [1,2,3], SCCP [4,5,6], TUP [13], etc.)
- * Support for the seamless operation of MTP3-User protocol peers
- * Support for the management of SCTP transport associations and traffic between an SG and one or more MGCs or IP-resident Databases
- * Support for MGC or IP-resident database process failover and load sharing
- * Support for the asynchronous reporting of status changes to management

In simplistic transport terms, the SG will terminate SS7 MTP2 and MTP3 protocol layers [7,8,9] and deliver ISUP, SCCP, and/or any other MTP3-User protocol messages, as well as certain MTP network management events, over SCTP transport associations to MTP3-User peers in MGCs or IP-resident databases.

1.2. Terminology

Application Server (AS) - A logical entity serving a specific Routing Key. An example of an Application Server is a virtual switch element handling all call processing for a signalling relation, identified by an SS7 DPC/OPC. Another example is a virtual database element, handling all HLR transactions for a particular SS7 SIO/DPC/OPC combination. The AS contains a set of one or more unique Application Server Processes, of which one or more is normally actively processing traffic. Note that there is a 1:1 relationship between an AS and a Routing Key.

Application Server Process (ASP) - A process instance of an Application Server. An Application Server Process serves as an active or backup process of an Application Server (e.g., part of a distributed virtual switch or database). Examples of ASPs are processes (or process instances) of MGCs, IP SCPs, or IP HLRs. An ASP contains an SCTP endpoint and may be configured to process signalling traffic within more than one Application Server.

Association - An association refers to an SCTP association. The association provides the transport for the delivery of MTP3-User protocol data units and M3UA adaptation layer peer messages.

IP Server Process (IPSP) - A process instance of an IP-based application. An IPSP is essentially the same as an ASP, except that it uses M3UA in a point-to-point fashion. Conceptually, an IPSP does not use the services of a Signalling Gateway node.

Failover - The capability to reroute signalling traffic as required to an alternate Application Server Process, or group of ASPs, within an Application Server in the event of failure or unavailability of a currently used Application Server Process. Failover also applies upon the return to service of a previously unavailable Application Server Process.

Host - The computing platform that the process (SGP, ASP or IPSP) is running on.

Layer Management - Layer Management is a nodal function that handles the inputs and outputs between the M3UA layer and a local management entity.

Linkset - A number of signalling links that directly interconnect two signalling points, which are used as a module.

MTP - The Message Transfer Part of the SS7 protocol.

MTP3 - MTP Level 3, the signalling network layer of SS7.

MTP3-User - Any protocol normally using the services of the SS7 MTP3 (e.g., ISUP, SCCP, TUP, etc.).

Network Appearance - The Network Appearance is a M3UA local reference shared by SG and AS (typically an integer) that, together with an Signaling Point Code, uniquely identifies an SS7 node by indicating the specific SS7 network to which it belongs. It can be used to distinguish between signalling traffic associated with different networks being sent between the SG and the ASP over a common SCTP association. An example scenario is where an SG appears as an

element in multiple separate national SS7 networks and the same Signaling Point Code value may be reused in different networks.

Network Byte Order - Most significant byte first, a.k.a Big Endian.
Routing Key - A Routing Key describes a set of SS7 parameters and parameter values that uniquely define the range of signalling traffic to be handled by a particular Application Server. Parameters within the Routing Key cannot extend across more than a single Signalling Point Management Cluster.

Routing Context - A value that uniquely identifies a Routing Key. Routing Context values are configured either using a configuration management interface, or by using the routing key management procedures defined in this document.

Signaling End Point (SEP) - A node in the SS7 network associated with an originating or terminating local exchange (switch) or a gateway exchange.

Signalling Gateway Process (SGP) - A process instance of a Signalling Gateway. It serves as an active, backup, load-sharing, or broadcast process of a Signalling Gateway.

Signalling Gateway (SG) - An SG is a signaling agent that receives/sends SCN native signaling at the edge of the IP network [12]. An SG appears to the SS7 network as an SS7 Signalling Point. An SG contains a set of one or more unique Signalling Gateway Processes, of which one or more is normally actively processing traffic. Where an SG contains more than one SGP, the SG is a logical entity, and the contained SGPs are assumed to be coordinated into a single management view to the SS7 network and to the supported Application Servers.

Signalling Process - A process instance that uses M3UA to communicate with other signalling processes. An ASP, an SGP, and an IPSP are all signalling processes.

Signalling Point Management Cluster (SPMC) - The complete set of Application Servers represented to the SS7 network under a single MTP entity (Signalling Point) in one specific Network Appearance. SPMCs are used to aggregate the availability, congestion, and user part status of an MTP entity (Signalling Point) that is distributed in the IP domain, for the purpose of supporting MTP3 management procedures towards the SS7 network. In some cases, the SG itself may also be a member of the SPMC. In this case, the SG availability/congestion/User_Part status should also be taken into account when considering any supporting MTP3 management actions.

Signaling Transfer Point (STP) - A node in the SS7 network that provides network access and performs message routing, screening and transfer of signaling messages.

Stream - An SCTP stream; a unidirectional logical channel established from one SCTP endpoint to another associated SCTP endpoint, within which all user messages are delivered in-sequence except for those submitted to the unordered delivery service.

1.3. M3UA Overview

1.3.1. Protocol Architecture

The framework architecture that has been defined for SCN signalling transport over IP [12] uses multiple components, including a common signalling transport protocol and an adaptation module to support the services expected by a particular SCN signalling protocol from its underlying protocol layer.

Within the framework architecture, this document defines an MTP3-User adaptation module suitable for supporting the transfer of messages of any protocol layer that is identified to the MTP Level 3 as an MTP User. The list of these protocol layers includes but is not limited to ISDN User Part (ISUP) [1,2,3], Signalling Connection Control Part (SCCP) [4,5,6], and Telephone User Part (TUP) [13]. TCAP [14,15,16] or RANAP [16] messages are transferred transparently by the M3UA protocol as SCCP payload, as they are SCCP-User protocols.

It is recommended that M3UA use the services of the Stream Control Transmission Protocol (SCTP) [18] as the underlying reliable common signalling transport protocol. This is to take advantage of various SCTP features, such as:

- Explicit packet-oriented delivery (not stream-oriented)
- Sequenced delivery of user messages within multiple streams, with an option for order-of-arrival delivery of individual user messages
- Optional multiplexing of user messages into SCTP datagrams
- Network-level fault tolerance through support of multi-homing at either or both ends of an association
- Resistance to flooding and masquerade attacks
- Data segmentation to conform to discovered path MTU size

Under certain scenarios, such as back-to-back connections without redundancy requirements, the SCTP functions above might not be a requirement, and TCP MAY be used as the underlying common transport protocol.

1.3.2. Services Provided by the M3UA Layer

The M3UA Layer at an ASP or IPSP provides the equivalent set of primitives at its upper layer to the MTP3-Users as provided by the MTP Level 3 to its local MTP3-Users at an SS7 SEP. In this way, the ISUP and/or SCCP layer at an ASP or IPSP is unaware that the expected MTP3 services are offered remotely from an MTP3 Layer at an SGP, and not by a local MTP3 layer. The MTP3 layer at an SGP may also be unaware that its local users are actually remote user parts over M3UA. In effect, the M3UA extends access to the MTP3 layer services to a remote IP-based application. The M3UA layer does not itself provide the MTP3 services. However, in the case where an ASP is connected to more than one SG, the M3UA layer at an ASP should maintain the status of configured SS7 destinations and route messages according to the availability and congestion status of the routes to these destinations via each SG.

The M3UA layer may also be used for point-to-point signalling between two IP Server Processes (IPSPs). In this case, the M3UA layer provides the same set of primitives and services at its upper layer as the MTP3. However, in this case the expected MTP3 services are not offered remotely from an SGP. The MTP3 services are provided, but the procedures to support these services are a subset of the MTP3 procedures, due to the simplified point-to-point nature of the IPSP-to-IPSP relationship.

1.3.2.1. Support for the Transport of MTP3-User Messages

The M3UA layer provides the transport of MTP-TRANSFER primitives across an established SCTP association between an SGP and an ASP or between IPSPs.

At an ASP, in the case where a destination is reachable via multiple SGPs, the M3UA layer must also choose via which SGP the message is to be routed or support load balancing across the SGPs, thereby minimizing missequencing.

The M3UA layer does not impose a 272-octet signalling information field (SIF) length limit as specified by the SS7 MTP Level 2 protocol [7,8,9]. Larger information blocks can be accommodated directly by M3UA/SCTP, without the need for an upper layer segmentation/re-assembly procedure as specified in recent SCCP or ISUP versions. However, in the context of an SG, the maximum 272-octet block size must be followed when interworking to a SS7 network that does not support the transfer of larger information blocks to the final destination. This avoids potential ISUP or SCCP fragmentation requirements at the SGPs. The provisioning and configuration of the SS7 network determines the restriction placed on the maximum block

size. Some configurations (e.g., Broadband MTP [19,20,22]) may permit larger block sizes.

1.3.2.2. Native Management Functions

The M3UA layer provides the capability to indicate errors associated with received M3UA messages and to notify, as appropriate, local management and/or the peer M3UA.

1.3.2.3. Interworking with MTP3 Network Management Functions

At the SGP, the M3UA layer provides interworking with MTP3 management functions to support seamless operation of the user SCN signalling applications in the SS7 and IP domains. This includes

- providing an indication to MTP3-Users at an ASP that a destination in the SS7 network is not reachable;
- providing an indication to MTP3-Users at an ASP that a destination in the SS7 network is now reachable;
- providing an indication to MTP3-Users at an ASP that messages to a destination in the SS7 network are experiencing SS7 congestion;
- providing an indication to the M3UA layer at an ASP that the routes to a destination in the SS7 network are restricted; and
- providing an indication to MTP3-Users at an ASP that a MTP3-User peer is unavailable.

The M3UA layer at an ASP keeps the state of the routes to remote SS7 destinations and may initiate an audit of the availability and the restricted or the congested state of remote SS7 destinations. This information is requested from the M3UA layer at the SGP.

The M3UA layer at an ASP may also indicate to the SG that the M3UA layer itself or the ASP or the ASP's Host is congested.

1.3.2.4. Support for the Management of SCTP Associations between the SGP and ASPs

The M3UA layer at the SGP maintains the availability state of all configured remote ASPs, to manage the SCTP Associations and the traffic between the M3UA peers. Also, the active/inactive and congestion state of remote ASPs is maintained.

The M3UA layer MAY be instructed by local management to establish an SCTP association to a peer M3UA node. This can be achieved using the

M-SCTP_ESTABLISH primitives (see Section 1.6.3 for a description of management primitives) to request, indicate, and confirm the establishment of an SCTP association with a peer M3UA node. In order to avoid redundant SCTP associations between two M3UA peers, one side (client) SHOULD be designated to establish the SCTP association, or M3UA configuration information maintained to detect redundant associations (e.g., via knowledge of the expected local and remote SCTP endpoint addresses).

Local management MAY request from the M3UA layer the status of the underlying SCTP associations using the M-SCTP_STATUS request and confirm primitives. Also, the M3UA MAY autonomously inform local management of the reason for the release of an SCTP association, determined either locally within the M3UA layer or by a primitive from the SCTP.

Also, the M3UA layer MAY inform the local management of the change in status of an ASP or AS. This MAY be achieved using the M-ASP_STATUS request or M-AS_STATUS request primitives.

1.3.2.5. Support for the Management of Connections to Multiple SGPs

As shown in Figure 1, an ASP may be connected to multiple SGPs. In such a case, a particular SS7 destination may be reachable via more than one SGP and/or SG; i.e., via more than one route. As MTP3 users only maintain status on a destination and not on a route basis, the M3UA layer must maintain the status (availability, restriction, and/or congestion of route to destination) of the individual routes, derive the overall availability or congestion status of the destination from the status of the individual routes, and inform the MTP3 users of this derived status whenever it changes.

1.4. Functional Areas

1.4.1. Signalling Point Code Representation

For example, within an SS7 network, a Signalling Gateway might be charged with representing a set of nodes in the IP domain into the SS7 network for routing purposes. The SG itself, as a signalling point in the SS7 network, might also be addressable with an SS7 Point Code for MTP3 Management purposes. The SG Point Code might also be used for addressing any local MTP3-Users at the SG such as a local SCCP layer.

equivalent, to allow rerouting between the SGs in the event of route failures. Where SGPs are used, inter-SGP communication might be used. Inter-SGP protocol is outside of the scope of this document.

The following example shows a signalling gateway partitioned into two network appearances.

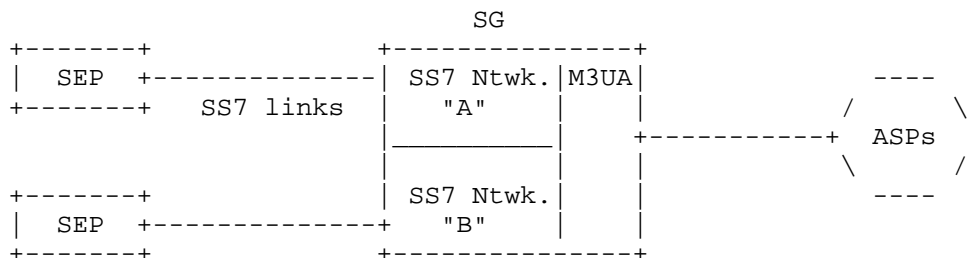

Figure 2. Example with multiple network

1.4.2. Routing Contexts and Routing Keys

1.4.2.1. Overview

The distribution of SS7 messages between the SGP and the Application Servers is determined by the Routing Keys and their associated Routing Contexts. A Routing Key is essentially a set of SS7 parameters used to filter SS7 messages, whereas the Routing Context parameter is a 4-octet value (integer) that is associated to that Routing Key in a 1:1 relationship. The Routing Context therefore can be viewed as an index into a sending node's Message Distribution Table containing the Routing Key entries.

Possible SS7 address/routing information that comprise a Routing Key entry includes, for example, the OPC, DPC, and SIO found in the MTP3 routing label. Some example Routing Keys are: the DPC alone, the DPC/OPC combination, or the DPC/OPC/SI combination. The particular information used to define an M3UA Routing Key is application and network dependent, and none of the above examples are mandated.

An Application Server Process may be configured to process signalling traffic related to more than one Application Server, over a single SCTP Association. In ASP Active and ASP Inactive management messages, the signalling traffic to be started or stopped is discriminated by the Routing Context parameter. At an ASP, the Routing Context parameter uniquely identifies the range of signalling traffic associated with each Application Server that the ASP is configured to receive.

1.4.2.2. Routing Key Limitations

Routing Keys SHOULD be unique in the sense that each received SS7 signalling message SHOULD have a full or partial match to a single routing result. An example of a partial match would be a default Routing Key that would be the result if there are no other Routing Keys to which the message belongs. It is not necessary for the parameter range values within a particular Routing Key to be contiguous.

1.4.2.3. Managing Routing Contexts and Routing Keys

There are two ways to provision a Routing Key at an SGP. A Routing Key may be configured statically using an implementation dependent management interface, or dynamically using the M3UA Routing Key registration procedure.

When using a management interface to configure Routing Keys, the message distribution function within the SGP is not limited to the set of parameters defined in this document. Other implementation-dependent distribution algorithms may be used.

1.4.2.4. Message Distribution at the SGP

To direct messages received from the SS7 MTP3 network to the appropriate IP destination, the SGP must perform a message distribution function using information from the received MTP3-User message.

To support this message distribution, the SGP might, for example, maintain the equivalent of a network address translation table, mapping incoming SS7 message information to an Application Server for a particular application and range of traffic. This could be accomplished by comparing elements of the incoming SS7 message to currently defined Routing Keys in the SGP.

These Routing Keys could in turn map directly to an Application Server that is enabled by one or more ASPs. These ASPs provide dynamic status information regarding their availability, traffic-handling capability and congestion to the SGP using various management messages defined in the M3UA protocol.

The list of ASPs in an AS is assumed to be dynamic, taking into account the availability, traffic-handling capability, and congestion status of the individual ASPs in the list, as well as configuration changes and possible failover mechanisms.

Normally, one or more ASPs are active (i.e., currently processing traffic) in the AS, but in certain failure and transition cases it is possible that there may be no active ASP available. Broadcast, loadsharing, and backup scenarios are supported.

When there is no matching Routing Key entry for an incoming SS7 message, a default treatment MAY be specified. Possible solutions are to provide a default Application Server at the SGP that directs all unallocated traffic to a (set of) default ASPs, or to drop the message and provide a notification to layer management. The treatment of unallocated traffic is implementation dependent.

1.4.2.5. Message Distribution at the ASP

The ASP must choose an SGP to direct a message to the SS7 network. This is accomplished by observing the Destination Point Code (and possibly other elements of the outgoing message, such as the SLS value). The ASP must also take into account whether the related Routing Context is active or not (see Section 4.3.4.3).

Implementation Note: Where more than one route (or SGP) is possible for routing to the SS7 network, the ASP could, for example, maintain a dynamic table of available SGP routes for the SS7 destinations, taking into account the SS7 destination availability/restricted/congestion status received from the SGP(s), the availability status of the individual SGPs, and configuration changes and failover mechanisms. There is, however, no M3UA messaging to manage the status of an SGP (e.g., SGP-Up/Down/Active/Inactive messaging).

Whenever an SCTP association to an SGP exists, the SGP is assumed to be ready for the purposes of responding to M3UA ASPSM messages (refer to Section 3).

1.4.3. SS7 and M3UA Interworking

In the case of SS7 and M3UA interworking, the M3UA adaptation layer is designed to provide an extension of the MTP3-defined user primitives.

1.4.3.1. Signalling Gateway SS7 Layers

The SG is responsible for terminating MTP Level 3 of the SS7 protocol, and offering an IP-based extension to its users.

From an SS7 perspective, it is expected that the Signalling Gateway transmits and receives SS7 Message Signalling Units (MSUs) over a standard SS7 network interface, using the SS7 Message Transfer Part (MTP) [7,8,9].

As a standard SS7 network interface, the use of MTP Level 2 signalling links is not the only possibility. ATM-based High Speed Links can also be used with the services of the Signalling ATM Adaptation Layer (SAAL) [19,20].

Note: It is also possible for IP-based interfaces to be present, using the services of the MTP2-User Adaptation Layer (M2UA) [24] or M2PA [25].

These could be terminated at a Signalling Transfer Point (STP) or Signalling End Point (SEP). Using the services of MTP3, the SG could be capable of communicating with remote SS7 SEPs in a quasi-associated fashion, where STPs may be present in the SS7 path between the SEP and the SG.

1.4.3.2. SS7 and M3UA Interworking at the SG

The SGP provides a functional interworking of transport functions between the SS7 network and the IP network by also supporting the M3UA adaptation layer. It allows the transfer of MTP3-User signalling messages to and from an IP-based Application Server Process where the peer MTP3-User protocol layer exists.

For SS7 user part management, it is required that the MTP3-User protocols at ASPs receive indications of SS7 signalling point availability, SS7 network congestion, and remote User Part unavailability, as would be expected in an SS7 SEP node. To accomplish this, the MTP-PAUSE, MTP-RESUME, and MTP-STATUS indication primitives received at the MTP3 upper layer interface at the SG need to be propagated to the remote MTP3-User lower layer interface at the ASP.

MTP3 management messages (such as TFAs or TFAs received from the SS7 network) MUST NOT be encapsulated as Data message Payload Data and sent either from SG to ASP or from ASP to SG. The SG MUST terminate these messages and generate M3UA messages, as appropriate.

1.4.3.3. Application Server

A cluster of application servers is responsible for providing the overall support for one or more SS7 upper layers. From an SS7 standpoint, a Signalling Point Management Cluster (SPMC) provides complete support for the upper layer service for a given point code.

As an example, an SPMC providing MGC capabilities could provide complete support for ISUP (and any other MTP3 user located at the point code of the SPMC) for a given point code.

In the case where an ASP is connected to more than one SGP, the M3UA layer must maintain the status of configured SS7 destinations and route messages according to the availability/congestion/restricted status of the routes to these SS7 destinations.

1.4.3.4. IPSP Considerations

Since IPSPs use M3UA in a point-to-point fashion, there is no concept of routing of messages beyond the remote end. Therefore, SS7 and M3UA interworking is not necessary for this model.

1.4.4. Redundancy Models

1.4.4.1 Application Server Redundancy

All MTP3-User messages (e.g., ISUP, SCCP) that match a provisioned Routing Key at an SGP are mapped to an Application Server.

The Application Server is the set of all ASPs associated with a specific Routing Key. Each ASP in this set may be active, inactive, or unavailable. Active ASPs handle traffic; inactive ASPs might be used when active ASPs become unavailable.

The failover model supports an "n+k" redundancy model, where "n" ASPs is the minimum number of redundant ASPs required to handle traffic and "k" ASPs are available to take over for a failed or unavailable ASP. Traffic SHOULD be sent after "n" ASPs are active. "k" ASPs MAY be either active at the same time as "n" or kept inactive until needed due to a failed or unavailable ASP.

A "1+1" active/backup redundancy is a subset of this model. A simplex "1+0" model is also supported as a subset, with no ASP redundancy.

1.4.5. Flow Control

Local Management at an ASP may wish to stop traffic across an SCTP association to temporarily remove the association from service or to perform testing and maintenance activity. The function could optionally be used to control the start of traffic on to a newly available SCTP association.

1.4.6. Congestion Management

The M3UA layer is informed of local and IP network congestion by means of an implementation-dependent function (e.g., an implementation-dependent indication from the SCTP of IP network congestion).

At an ASP or IPSP, the M3UA layer indicates IP network congestion to local MTP3-Users by means of an MTP-STATUS primitive, as per current MTP3 procedures, to invoke appropriate upper-layer responses.

When an SG determines that the transport of SS7 messages to a Signalling Point Management Cluster (SPMC) is encountering IP network congestion, the SG MAY trigger SS7 MTP3 Transfer Controlled management messages to originating SS7 nodes, per the congestion procedures of the relevant MTP3 standard. The triggering of SS7 MTP3 Management messages from an SG is an implementation-dependent function.

The M3UA layer at an ASP or IPSP MAY indicate local congestion to an M3UA peer with an SCON message. When an SG receives a congestion message (SCON) from an ASP and the SG determines that an SPMC is now encountering congestion, it MAY trigger SS7 MTP3 Transfer Controlled management messages to concerned SS7 destinations according to congestion procedures of the relevant MTP3 standard.

1.4.7. SCTP Stream Mapping

The M3UA layer at both the SGP and ASP also supports the assignment of signalling traffic into streams within an SCTP association. Traffic that requires sequencing SHOULD be assigned to the same stream. To accomplish this, MTP3-User traffic may be assigned to individual streams based on, for example, the SLS value in the MTP3 Routing Label, subject of course to the maximum number of streams supported by the underlying SCTP association.

The following rules apply (see Section 3.1.2):

1. The DATA message MUST NOT be sent on stream 0.
2. The ASPSM, MGMT, RKM classes SHOULD be sent on stream 0 (other than BEAT, BEAT ACK and NTFY messages).
3. The SSNM, ASPTM classes and BEAT, BEAT ACK and NTFY messages can be sent on any stream.

1.4.8. SCTP Client/Server Model

It is recommended that the SGP and ASP be able to support both client and server operation. The peer endpoints using M3UA SHOULD be

configured so that one always takes on the role of client and the other the role of server for initiating SCTP associations. The default orientation would be for the SGP to take on the role of server while the ASP is the client. In this case, ASPs SHOULD initiate the SCTP association to the SGP.

In the case of IPSP to IPSP communication, the peer endpoints using M3UA SHOULD be configured so that one always takes on the role of client and the other the role of server for initiating SCTP associations.

The SCTP and TCP Registered User Port Number Assignment for M3UA is 2905.

1.5. Sample Configuration

1.5.1. Example 1: ISUP Message Transport

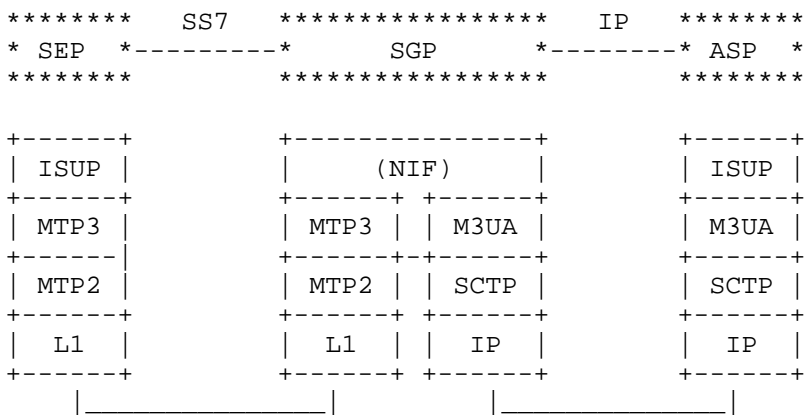

SEP - SS7 Signalling End Point
SCTP - Stream Control Transmission Protocol
NIF - Nodal Interworking Function

In this example, the SGP provides an implementation-dependent nodal interworking function (NIF) that allows the MGC to exchange SS7 signalling messages with the SS7-based SEP. The NIF within the SGP serves as the interface within the SGP between the MTP3 and M3UA. This nodal interworking function has no visible peer protocol with either the MGC or SEP. It also provides network status information to one or both sides of the network.

For internal SGP modeling purposes, at the NIF level, SS7 signalling messages that are destined to the MGC are received as MTP-TRANSFER indication primitives from the MTP Level 3 upper layer interface,

translated to MTP-TRANSFER request primitives, and sent to the local M3UA-resident message distribution function for ongoing routing to the final IP destination. Messages received from the local M3UA network address translation and mapping function as MTP-TRANSFER indication primitives are sent to the MTP Level 3 upper-layer interface as MTP-TRANSFER request primitives for ongoing MTP Level 3 routing to an SS7 SEP. For the purposes of providing SS7 network status information, the NIF also delivers MTP-PAUSE, MTP-RESUME, and MTP-STATUS indication primitives received from the MTP Level 3 upper-layer interface to the local M3UA-resident management function. In addition, as an implementation and network option, restricted destinations are communicated from MTP network management to the local M3UA-resident management function.

1.5.2. Example 2: SCCP Transport between IPSPs

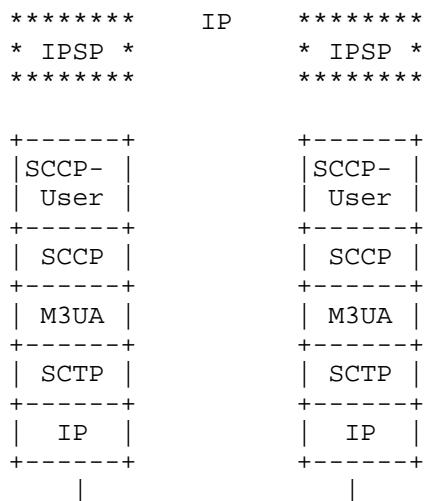

This example shows an architecture where no Signalling Gateway is used. In this example, SCCP messages are exchanged directly between two IP-resident IPSPs with resident SCCP-User protocol instances, such as RANAP or TCAP. SS7 network interworking is not required; therefore, there is no MTP3 network management status information for the SCCP and SCCP-User protocols to consider. Any MTP-PAUSE, MTP-RESUME, or MTP-STATUS indications from the M3UA layer to the SCCP layer should consider the status of the Sctp Association and underlying IP network and any congestion information received from the remote site.

1.5.3. Example 3: SGP Resident SCCP Layer, with Remote ASP

```

*****  SS7  *****  IP  *****
* SEP *-----*          *-----*  *
* or  *          *   SGP   *          * ASP *
* STP *          *          *          *
*****  *****  *****
    
```

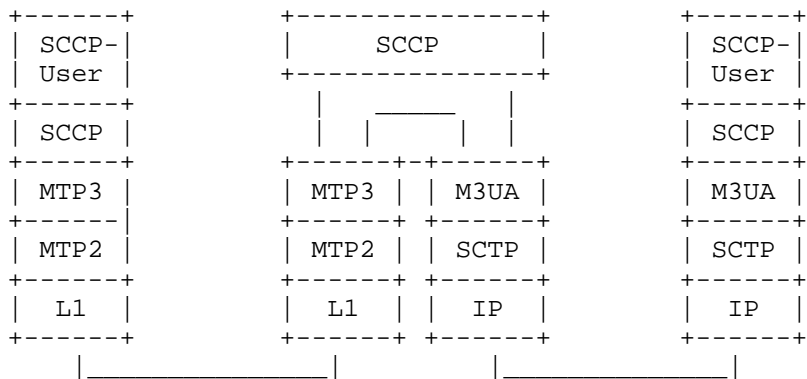

STP - SS7 Signalling Transfer Point

In this example, the SGP contains an instance of the SS7 SCCP protocol layer that may, for example, perform the SCCP Global Title Translation (GTT) function for messages logically addressed to the SG SCCP. If the result of a GTT for an SCCP message yields an SS7 DPC or DPC/SSN address of an SCCP peer located in the IP domain, the resulting MTP-TRANSFER request primitive is sent to the local M3UA-resident network address translation and mapping function for ongoing routing to the final IP destination.

Similarly, the SCCP instance in an SGP can perform the SCCP GTT service for messages logically addressed to it from SCCP peers in the IP domain. In this case, MTP-TRANSFER indication primitives are sent from the local M3UA-resident network address translation and mapping function to the SCCP for GTT. If the result of the GTT yields the address of an SCCP peer in the SS7 network, then the resulting MTP-TRANSFER request primitive is given to the MTP3 for delivery to an SS7-resident node.

It is possible that the above SCCP GTT at the SGP could yield the address of an SCCP peer in the IP domain, and that the resulting MTP-TRANSFER request primitive would be sent back to the M3UA layer for delivery to an IP destination.

For internal SGP modeling purposes, this may be accomplished with the use of an implementation-dependent nodal interworking function within the SGP that effectively sits below the SCCP and routes MTP-TRANSFER request/indication messages to/from both the MTP3 and the M3UA layer, based on the SS7 DPC or DPC/SI address information. This nodal interworking function has no visible peer protocol with either the ASP or SEP.

Note that the services and interface provided by the M3UA layer are the same as in Example 1 and that the functions taking place in the SCCP entity are transparent to the M3UA layer. The SCCP protocol functions are not reproduced in the M3UA protocol.

1.6. Definition of M3UA Boundaries

This section provides a definition of the boundaries of the M3UA protocol. They consist of SCTP, Layer Management, and the MTP3-User.

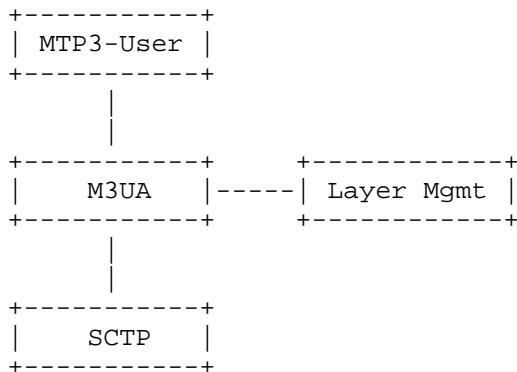

1.6.1. Definition of the Boundary between M3UA and an MTP3-User

From ITU Q.701 [7]:

- MTP-TRANSFER request
- MTP-TRANSFER indication
- MTP-PAUSE indication
- MTP-RESUME indication
- MTP-STATUS indication

1.6.2. Definition of the Boundary between M3UA and SCTP

An example of the upper-layer primitives provided by the SCTP are provided in Reference [18], Section 10.

1.6.3. Definition of the Boundary between M3UA and Layer Management

M-SCTP_ESTABLISH request

Direction: LM -> M3UA

Purpose: LM requests that ASP establish an SCTP association with its peer.

M-SCTP_ESTABLISH confirm

Direction: M3UA -> LM

Purpose: ASP confirms to LM that it has established an SCTP association with its peer.

M-SCTP_ESTABLISH indication

Direction: M3UA -> LM

Purpose: M3UA informs LM that a remote ASP has established an SCTP association.

M-SCTP_RELEASE request

Direction: LM -> M3UA

Purpose: LM requests that ASP release an SCTP association with its peer.

M-SCTP_RELEASE confirm

Direction: M3UA -> LM

Purpose: ASP confirms to LM that it has released SCTP association with its peer.

M-SCTP_RELEASE indication

Direction: M3UA -> LM

Purpose: M3UA informs LM that a remote ASP has released an SCTP Association or that the SCTP association has failed.

M-SCTP_RESTART indication

Direction: M3UA -> LM

Purpose: M3UA informs LM that an SCTP restart indication has been received.

M-SCTP_STATUS request

Direction: LM -> M3UA

Purpose: LM requests that M3UA report the status of an SCTP association.

M-SCTP_STATUS confirm

Direction: M3UA -> LM

Purpose: M3UA responds with the status of an SCTP association.

M-SCTP STATUS indication

Direction: M3UA -> LM

Purpose: M3UA reports the status of an SCTP association.

M-ASP_STATUS request

Direction: LM -> M3UA

Purpose: LM requests that M3UA report the status of a local or remote ASP.

M-ASP_STATUS confirm

Direction: M3UA -> LM

Purpose: M3UA reports the status of local or remote ASP.

M-AS_STATUS request

Direction: LM -> M3UA

Purpose: LM requests that M3UA report the status of an AS.

M-AS_STATUS confirm

Direction: M3UA -> LM

Purpose: M3UA reports the status of an AS.

M-NOTIFY indication

Direction: M3UA -> LM

Purpose: M3UA reports that it has received a Notify message from its peer.

M-ERROR indication

Direction: M3UA -> LM

Purpose: M3UA reports that it has received an Error message from its peer or that a local operation has been unsuccessful.

M-ASP_UP request

Direction: LM -> M3UA

Purpose: LM requests that ASP start its operation and send an ASP Up message to its peer.

M-ASP_UP confirm

Direction: M3UA -> LM

Purpose: ASP reports that it has received an ASP UP Ack message from its peer.

M-ASP_UP indication

Direction: M3UA -> LM

Purpose: M3UA reports that it has successfully processed an incoming ASP Up message from its peer.

M-ASP_DOWN request
Direction: LM -> M3UA
Purpose: LM requests that ASP stop its operation and send an ASP Down message to its peer.

M-ASP_DOWN confirm
Direction: M3UA -> LM
Purpose: ASP reports that it has received an ASP Down Ack message from its peer.

M-ASP_DOWN indication
Direction: M3UA -> LM
Purpose: M3UA reports that it has successfully processed an incoming ASP Down message from its peer, or the SCTP association has been lost/reset.

M-ASP_ACTIVE request
Direction: LM -> M3UA
Purpose: LM requests that ASP send an ASP Active message to its peer.

M-ASP_ACTIVE confirm
Direction: M3UA -> LM
Purpose: ASP reports that it has received an ASP Active Ack message from its peer.

M-ASP_ACTIVE indication
Direction: M3UA -> LM
Purpose: M3UA reports that it has successfully processed an incoming ASP Active message from its peer.

M-ASP_INACTIVE request
Direction: LM -> M3UA
Purpose: LM requests that ASP send an ASP Inactive message to its peer.

M-ASP_INACTIVE confirm
Direction: LM -> M3UA
Purpose: ASP reports that it has received an ASP Inactive Ack message from its peer.

M-ASP_INACTIVE indication
Direction: M3UA -> LM
Purpose: M3UA reports that it has successfully processed an incoming ASP Inactive message from its peer.

M-AS_ACTIVE indication
Direction: M3UA -> LM
Purpose: M3UA reports that an AS has moved to the AS-ACTIVE state.

M-AS_INACTIVE indication

Direction: M3UA -> LM

Purpose: M3UA reports that an AS has moved to the AS-INACTIVE state.

M-AS_DOWN indication

Direction: M3UA -> LM

Purpose: M3UA reports that an AS has moved to the AS-DOWN state.

If dynamic registration of RK is supported by the M3UA layer, the layer MAY support the following additional primitives:

M-RK_REG request

Direction: LM -> M3UA

Purpose: LM requests that ASP register RK(s) with its peer by sending an REG REQ message

M-RK_REG confirm

Direction: M3UA -> LM

Purpose: ASP reports that it has received REG RSP message with a registration status of successful from its peer.

M-RK_REG indication

Direction: M3UA -> LM

Purpose: M3UA informs LM that it has successfully processed an incoming REG REQ message.

M-RK_DEREG request

Direction: LM -> M3UA

Purpose: LM requests that ASP deregister RK(s) with its peer by sending a DEREG REQ message.

M-RK_DEREG confirm

Direction: M3UA -> LM

Purpose: ASP reports that it has received DEREG REQ message with a deregistration status of successful from its peer.

M-RK_DEREG indication

Direction: M3UA -> LM

Purpose: M3UA informs LM that it has successfully processed an incoming DEREG REQ from its peer.

2. Conventions

In this document, the keywords MUST, MUST NOT, REQUIRED, SHALL, SHALL NOT, SHOULD, SHOULD NOT, RECOMMENDED, NOT RECOMMENDED, MAY, and OPTIONAL are to be interpreted as described in [21].

3. M3UA Protocol Elements

The general M3UA message format includes a Common Message Header followed by zero or more parameters as defined by the Message Type. For forward compatibility, all Message Types may have attached parameters even if none are specified in this version.

3.1. Common Message Header

The protocol messages for MTP3-User Adaptation require a message header that contains the adaptation layer version, the message type, and message length.

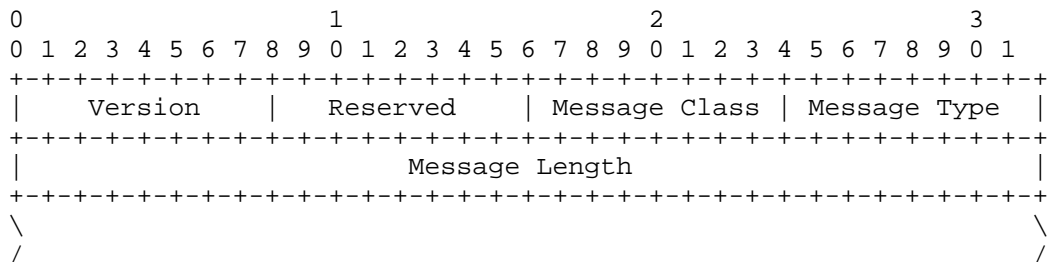

All fields in an M3UA message MUST be transmitted in network byte order, unless otherwise stated.

3.1.1. M3UA Protocol Version: 8 bits (unsigned integer)

The version field contains the version of the M3UA adaptation layer.

The supported versions are as follows:

- 1 Release 1.0

3.1.2. Message Classes and Types

The following list contains the valid Message Classes:

Message Class: 8 bits (unsigned integer)

The following list contains the valid Message Type Classes:

- 0 Management (MGMT) Messages
- 1 Transfer Messages
- 2 SS7 Signalling Network Management (SSNM) Messages
- 3 ASP State Maintenance (ASPSM) Messages
- 4 ASP Traffic Maintenance (ASPTM) Messages
- 5 Reserved for Other SIGTRAN Adaptation Layers

- 6 Reserved for Other SIGTRAN Adaptation Layers
- 7 Reserved for Other SIGTRAN Adaptation Layers
- 8 Reserved for Other SIGTRAN Adaptation Layers
- 9 Routing Key Management (RKM) Messages
- 10 to 127 Reserved by the IETF
- 128 to 255 Reserved for IETF-Defined Message Class extensions

Message Type: 8 bits (unsigned integer)

The following list contains the message types for the defined messages.

Management (MGMT) Messages (see Section 3.8)

- 0 Error (ERR)
- 1 Notify (NTFY)
- 2 to 127 Reserved by the IETF
- 128 to 255 Reserved for IETF-Defined MGMT extensions

Transfer Messages (see Section 3.3)

- 0 Reserved
- 1 Payload Data (DATA)
- 2 to 127 Reserved by the IETF
- 128 to 255 Reserved for IETF-Defined Transfer extensions

SS7 Signalling Network Management (SSNM) Messages (see Section 3.4)

- 0 Reserved
- 1 Destination Unavailable (DUNA)
- 2 Destination Available (DAVA)
- 3 Destination State Audit (DAUD)
- 4 Signalling Congestion (SCON)
- 5 Destination User Part Unavailable (DUPU)
- 6 Destination Restricted (DRST)
- 7 to 127 Reserved by the IETF
- 128 to 255 Reserved for IETF-Defined SSNM extensions

ASP State Maintenance (ASPSM) Messages (see Section 3.5)

- 0 Reserved
- 1 ASP Up (ASPUP)
- 2 ASP Down (ASPDN)
- 3 Heartbeat (BEAT)
- 4 ASP Up Acknowledgement (ASPUP ACK)
- 5 ASP Down Acknowledgement (ASPDN ACK)
- 6 Heartbeat Acknowledgement (BEAT ACK)

7 to 127 Reserved by the IETF
 128 to 255 Reserved for IETF-Defined ASPSM extensions

ASP Traffic Maintenance (ASPTM) Messages (see Section 3.7)

0 Reserved
 1 ASP Active (ASPAC)
 2 ASP Inactive (ASPIA)
 3 ASP Active Acknowledgement (ASPAC ACK)
 4 ASP Inactive Acknowledgement (ASPIA ACK)
 5 to 127 Reserved by the IETF
 128 to 255 Reserved for IETF-Defined ASPTM extensions

Routing Key Management (RKM) Messages (see Section 3.6)

0 Reserved
 1 Registration Request (REG REQ)
 2 Registration Response (REG RSP)
 3 Deregistration Request (DEREG REQ)
 4 Deregistration Response (DEREG RSP)
 5 to 127 Reserved by the IETF
 128 to 255 Reserved for IETF-Defined RKM extensions

3.1.3. Reserved: 8 Bits

The Reserved field SHOULD be set to all '0's and ignored by the receiver.

3.1.4. Message Length: 32-Bits (Unsigned Integer)

The Message Length defines the length of the message in octets, including the Common Header. The Message Length MUST include parameter padding octets, if there are any.

Note: A receiver SHOULD accept the message whether or not the final parameter padding is included in the message length.

3.2. Variable-Length Parameter Format

M3UA messages consist of a Common Header followed by zero or more variable-length parameters, as defined by the message type. All the parameters contained in a message are defined in a Tag Length-Value format, as shown below.

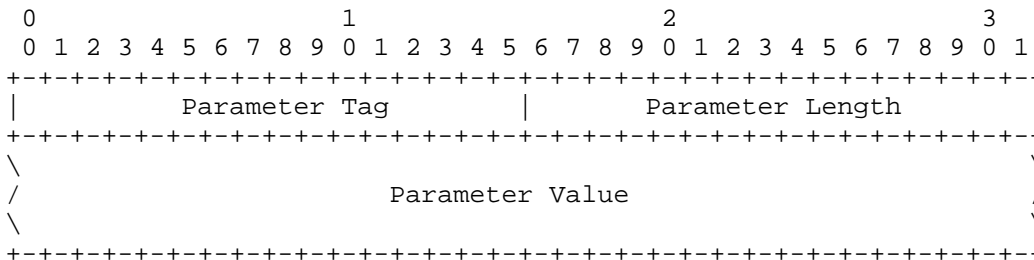

Where more than one parameter is included in a message, the parameters may be in any order, except where explicitly mandated. A receiver SHOULD accept the parameters in any order.

Unless explicitly stated or shown in a message format diagram, only one parameter of the same type is allowed in a message.

Parameter Tag: 16 bits (unsigned integer)

The Tag field is a 16-bit identifier of the type of parameter. It takes a value of 0 to 65534. Common parameters used by adaptation layers are in the range of 0x00 to 0x3f. M3UA-specific parameters have Tags in the range 0x0200 to 0x02ff. The parameter Tags defined are as follows:

Common Parameters. These TLV parameters are common across the different adaptation layers:

Parameter Name =====	Parameter ID =====
Reserved	0x0000
Not Used in M3UA	0x0001
Not Used in M3UA	0x0002
Not Used in M3UA	0x0003
INFO String	0x0004
Not Used in M3UA	0x0005
Routing Context	0x0006
Diagnostic Information	0x0007
Not Used in M3UA	0x0008
Heartbeat Data	0x0009
Not Used in M3UA	0x000a
Traffic Mode Type	0x000b
Error Code	0x000c
Status	0x000d
Not Used in M3UA	0x000e
Not Used in M3UA	0x000f
Not Used in M3UA	0x0010
ASP Identifier	0x0011

Affected Point Code	0x0012
Correlation ID	0x0013

M3UA-Specific parameters. These TLV parameters are specific to the M3UA protocol:

Network Appearance	0x0200
Reserved	0x0201
Reserved	0x0202
Reserved	0x0203
User/Cause	0x0204
Congestion Indications	0x0205
Concerned Destination	0x0206
Routing Key	0x0207
Registration Result	0x0208
Deregistration Result	0x0209
Local Routing Key Identifier	0x020a
Destination Point Code	0x020b
Service Indicators	0x020c
Reserved	0x020d
Originating Point Code List	0x020e
Reserved	0x020f
Protocol Data	0x0210
Reserved	0x0211
Registration Status	0x0212
Deregistration Status	0x0213
Reserved by the IETF	0x0214 to 0xffff

The value of 65535 is reserved for IETF-defined extensions. Values other than those defined in specific parameter descriptions are reserved for use by the IETF. An RFC is required to make use of parameter values "Reserved by the IETF".

Parameter Length: 16 bits (unsigned integer)

The Parameter Length field contains the size of the parameter in octets, including the Parameter Tag, Parameter Length, and Parameter Value fields. Thus, a parameter with a zero-length Parameter Value field would have a Length field of 4. The Parameter Length does not include any padding octets. If the parameter contains subparameters, the Parameter Length field will include all the octets of each subparameter, including subparameter padding octets (if there are any).

Parameter Value: variable length

The Parameter Value field contains the actual information to be transferred in the parameter.

The total length of a parameter (including Tag, Parameter Length, and Value fields) MUST be a multiple of 4 octets. If the length of the parameter is not a multiple of 4 octets, the sender pads the Parameter at the end (i.e., after the Parameter Value field) with all zero octets. The length of the padding is NOT included in the parameter length field. A sender MUST NOT pad with more than 3 octets. The receiver MUST ignore the padding octets.

3.3. Transfer Messages

The following section describes the Transfer messages and parameter contents.

3.3.1. Payload Data Message (DATA)

The DATA message contains the SS7 MTP3-User protocol data, which is an MTP-TRANSFER primitive, including the complete MTP3 Routing Label. The DATA message contains the following variable-length parameters:

Network Appearance	Optional
Routing Context	Conditional
Protocol Data	Mandatory
Correlation Id	Optional

The following format MUST be used for the Data Message:

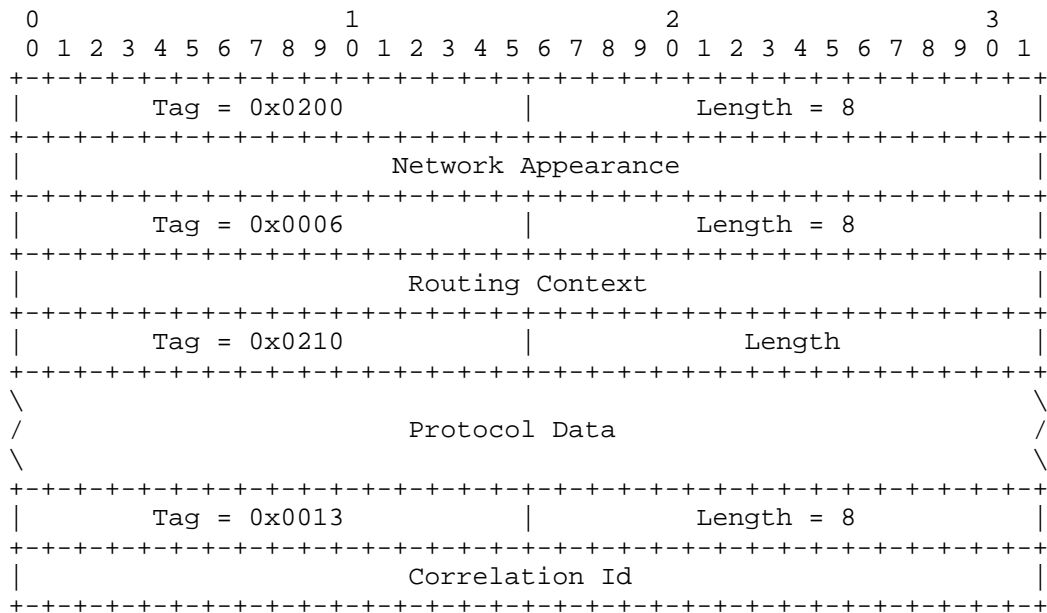

Network Appearance: 32 bits (unsigned integer)

The Network Appearance parameter identifies the SS7 network context for the message and implicitly identifies the SS7 Point Code format used, the SS7 Network Indicator value, and the MTP3 and possibly the MTP3-User protocol type/variant/version used within the specific SS7 network. Where an SG operates in the context of a single SS7 network, or if individual SCTP associations are dedicated to each SS7 network context, the Network Appearance parameter is not required. In other cases, the parameter may be configured to be present for the use of the receiver.

The Network Appearance parameter value is of local significance only, coordinated between the SGP and ASP. Therefore, in the case where an ASP is connected to more than one SGP, the same SS7 network context may be identified by different Network Appearance values, depending on which SGP a message is being transmitted/received.

Where the optional Network Appearance parameter is present, it MUST be the first parameter in the message, as it defines the format of the Protocol Data field.

IMPLEMENTATION NOTE: For simplicity of configuration, it may be desirable to use the same NA value across all nodes sharing a particular network context.

Routing Context: 32 bits (unsigned integer)

The Routing Context parameter contains the Routing Context value associated with the DATA message. Where a Routing Key has not been coordinated between the SGP and ASP, sending of Routing Context is not required. Where multiple Routing Keys and Routing Contexts are used across a common association, the Routing Context MUST be sent to identify the traffic flow, assisting in the internal distribution of Data messages.

Protocol Data: variable length

The Protocol Data parameter contains the original SS7 MTP3 message, including the Service Information Octet and Routing Label.

The Protocol Data parameter contains the following fields:

Service Indicator
Network Indicator
Message Priority

Destination Point Code
Originating Point Code

Signalling Link Selection Code (SLS)

User Protocol Data, which includes

MTP3-User protocol elements (e.g., ISUP, SCCP, or TUP parameters)

The Protocol Data parameter is encoded as follows:

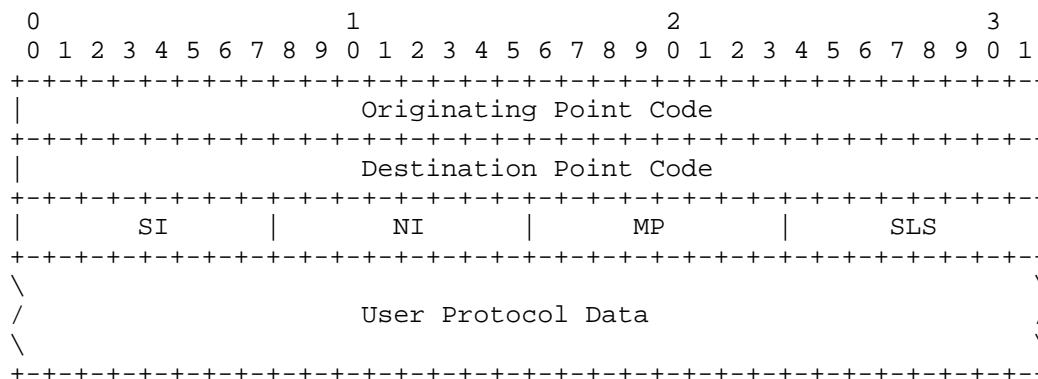

Originating Point Code: 32 bits (unsigned integer)

Destination Point Code: 32 bits (unsigned integer)

The Originating and Destination Point Code fields contains the OPC and DPC from the routing label of the original SS7 message in Network Byte Order, justified to the least significant bit. Unused bits are coded '0'.

Service Indicator: 8 bits (unsigned integer)

The Service Indicator field contains the SI field from the original SS7 message justified to the least significant bit. Unused bits are coded '0'.

Network Indicator: 8 bits (unsigned integer)

The Network Indicator contains the NI field from the original SS7 message justified to the least significant bit. Unused bits are coded '0'.

Message Priority: 8 bits (unsigned integer)

The Message Priority field contains the MP bits (if any) from the original SS7 message, both for ANSI-style and TTC-style [26] message priority bits. The MP bits are aligned to the least significant bit. Unused bits are coded '0'.

Signalling Link Selection: 8 bits (unsigned integer)

The Signalling Link Selection field contains the SLS bits from the routing label of the original SS7 message justified to the least significant bit and in Network Byte Order. Unused bits are coded '0'.

User Protocol Data: variable-length octet string

The User Protocol Data field contains an octet string of MTP-User information from the original SS7 message, starting with the first octet of the original SS7 message following the Routing Label [7][8][26].

Correlation Id: 32 bits (unsigned integer)

The Correlation Id parameter uniquely identifies the MSU carried in the Protocol Data within an AS. This Correlation Id parameter is assigned by the sending M3UA.

3.4. SS7 Signalling Network Management (SSNM) Messages

3.4.1. Destination Unavailable (DUNA)

The DUNA message is sent from an SGP in an SG to all concerned ASPs to indicate that the SG has determined that one or more SS7 destinations are unreachable. It is also sent by an SGP in response to a message from the ASP to an unreachable SS7 destination. As an implementation option, the SG may suppress the sending of subsequent "response" DUNA messages regarding a certain unreachable SS7 destination for a certain period to give the remote side time to react. If there is no alternate route via another SG, the MTP3-User at the ASP is expected to stop traffic to the affected destination via the SG as per the defined MTP3-User procedures.

The DUNA message contains the following parameters:

Network Appearance	Optional
Routing Context	Conditional
Affected Point Code	Mandatory
INFO String	Optional

The format for DUNA Message parameters is as follows:

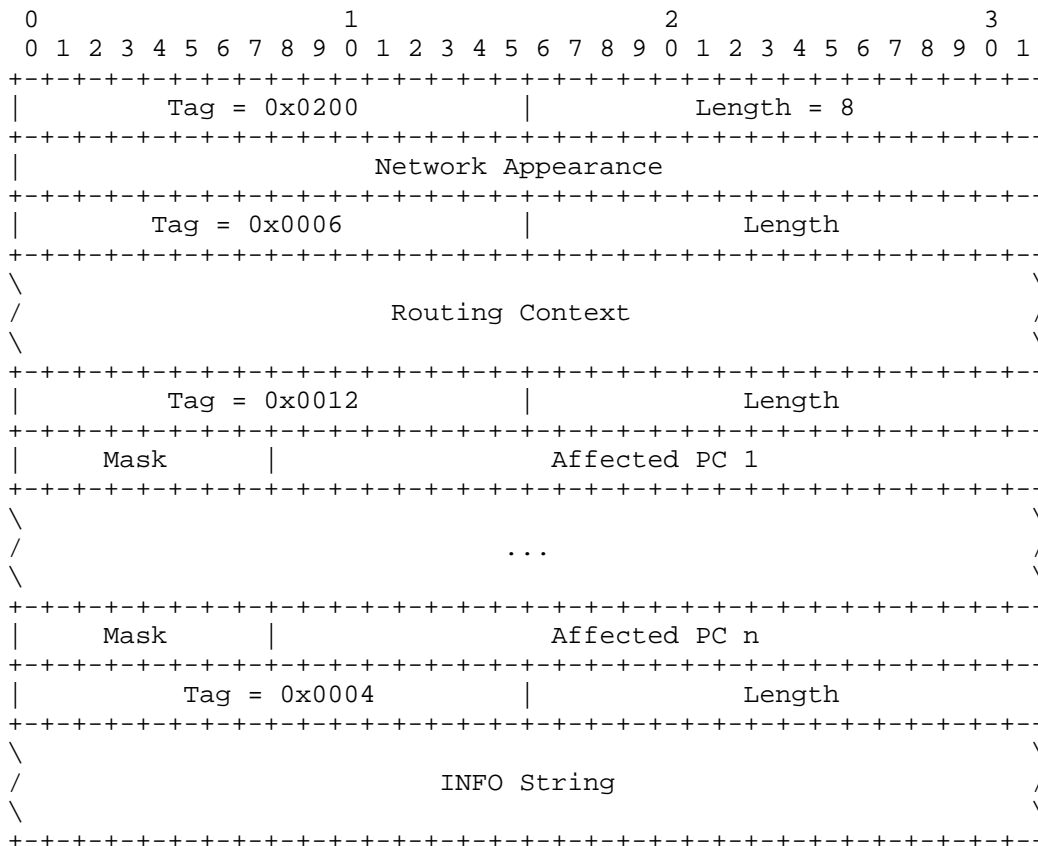

Network Appearance: 32-bit unsigned integer

The description of Network Appearance in Section 3.3.1 applies, with the exception that Network Appearance does not have to be the first parameter in this message.

Routing Context: n x 32 bits (unsigned integer)

The conditional Routing Context parameter contains the Routing Context values associated with the DUNA message. Where a Routing Key has not been coordinated between the SGP and ASP, sending of Routing Context is not required. Where multiple Routing Keys and Routing Contexts are used across a common association, the Routing Context(s) MUST be sent to identify the concerned traffic flows for which the DUNA message applies, assisting in outgoing traffic management and internal distribution of MTP-PAUSE indications to MTP3-Users at the receiver.

Affected Point Code: n x 32 bits

The Affected Point Code parameter contains a list of Affected Destination Point Code fields, each a three-octet parameter to allow for 14-, 16-, and 24-bit binary formatted SS7 Point Codes. Affected Point Codes that are less than 24 bits are padded on the left to the 24-bit boundary. The encoding is shown below for ANSI and ITU Point Code examples.

ANSI 24-bit Point Code

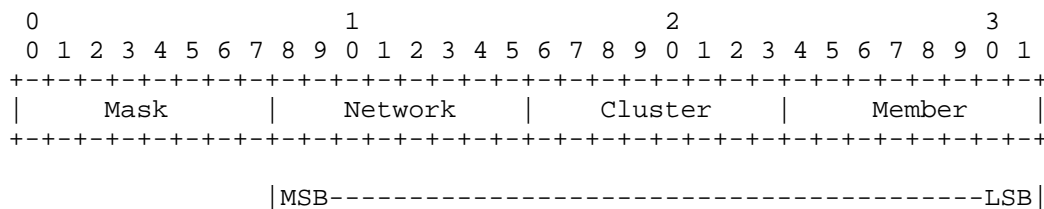

ITU 14-bit Point Code

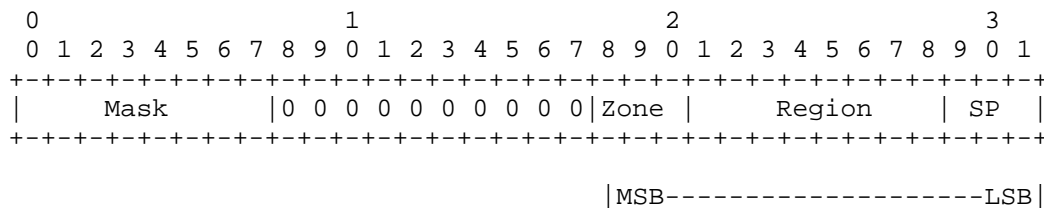

It is optional to send an Affected Point Code parameter with more than one Affected PC, but it is mandatory to receive it. Including multiple Affected PCs may be useful when receipt of an MTP3 management message or a linkset event simultaneously affects the availability status of a list of destinations at an SG.

Mask: 8 bits (unsigned integer)

The Mask field can be used to identify a contiguous range of Affected Destination Point Codes. Identifying a contiguous range of Affected DPCs may be useful when receipt of an MTP3 management message or a linkset event simultaneously affects the availability status of a series of destinations at an SG.

The Mask parameter is an integer representing a bit mask that can be applied to the related Affected PC field. The bit mask identifies how many bits of the Affected PC field are significant and which are effectively "wildcarded". For example, a mask of "8" indicates that the last eight bits of the PC are "wildcarded". For an ANSI 24-bit Affected PC, this is equivalent to signalling that all PCs in an ANSI Cluster are unavailable. A mask of "3" indicates that the last three bits of the PC are "wildcarded". For a 14-bit ITU Affected PC, this is equivalent to signaling that an ITU Region is unavailable. A mask value equal (or greater than) the number of bits in the PC indicates that the entire network appearance is affected; this is used to indicate network isolation to the ASP.

INFO String: variable length

The optional INFO String parameter can carry any meaningful UTF-8 [10] character string along with the message. Length of the INFO String parameter is from 0 to 255 octets. No procedures are presently identified for its use, but the INFO String MAY be used for debugging purposes. An INFO String with a zero-length parameter is not considered an error (a zero length parameter is one in which the Length field in the TLV will be set to 4).

3.4.2. Destination Available (DAVA)

The DAVA message is sent from an SGP to all concerned ASPs to indicate that the SG has determined that one or more SS7 destinations are now reachable (and not restricted), or in response to a DAUD message, if appropriate. If the ASP M3UA layer previously had no routes to the affected destinations, the ASP MTP3-User protocol is informed and may now resume traffic to the affected destination. The ASP M3UA layer now routes the MTP3-user traffic through the SG initiating the DAVA message.

The DAVA message contains the following parameters:

Network Appearance	Optional
Routing Context	Conditional
Affected Point Code	Mandatory
INFO String	Optional

The format and description of the Network Appearance, Routing Context, Affected Point Code, and INFO String parameters are the same as for the DUNA message (See Section 3.4.1).

3.4.3. Destination State Audit (DAUD)

The DAUD message MAY be sent from the ASP to the SGP to audit the availability/congestion state of SS7 routes from the SG to one or more affected destinations.

The DAUD message contains the following parameters:

Network Appearance	Optional
Routing Context	Conditional
Affected Point Code	Mandatory
INFO String	Optional

The format and description of DAUD Message parameters are the same as for the DUNA message (See Section 3.4.1).

It is recommended that during normal operation (traffic handling) the mask field of the Affected Point Code parameter in the DAUD message be kept to a zero value in order to avoid SG overloading.

3.4.4. Signalling Congestion (SCON)

The SCON message can be sent from an SGP to all concerned ASPs to indicate that an SG has determined that there is congestion in the SS7 network to one or more destinations, or to an ASP in response to a DATA or DAUD message, as appropriate. For some MTP protocol variants (e.g., ANSI MTP) the SCON message may be sent when the SS7 congestion level changes. The SCON message MAY also be sent from the M3UA layer of an ASP to an M3UA peer, indicating that the congestion level of the M3UA layer or the ASP has changed.

IMPLEMENTATION NOTE: An M3UA node may maintain a timer to control congestion notification validity, if desired. This timer will be useful in cases where the peer node fails to indicate congestion abatement.

The SCON message contains the following parameters:

Network Appearance	Optional
Routing Context	Conditional
Affected Point Code	Mandatory
Concerned Destination	Optional
Congestion Indications	Optional
INFO String	Optional

The format for SCON Message parameters is as follows:

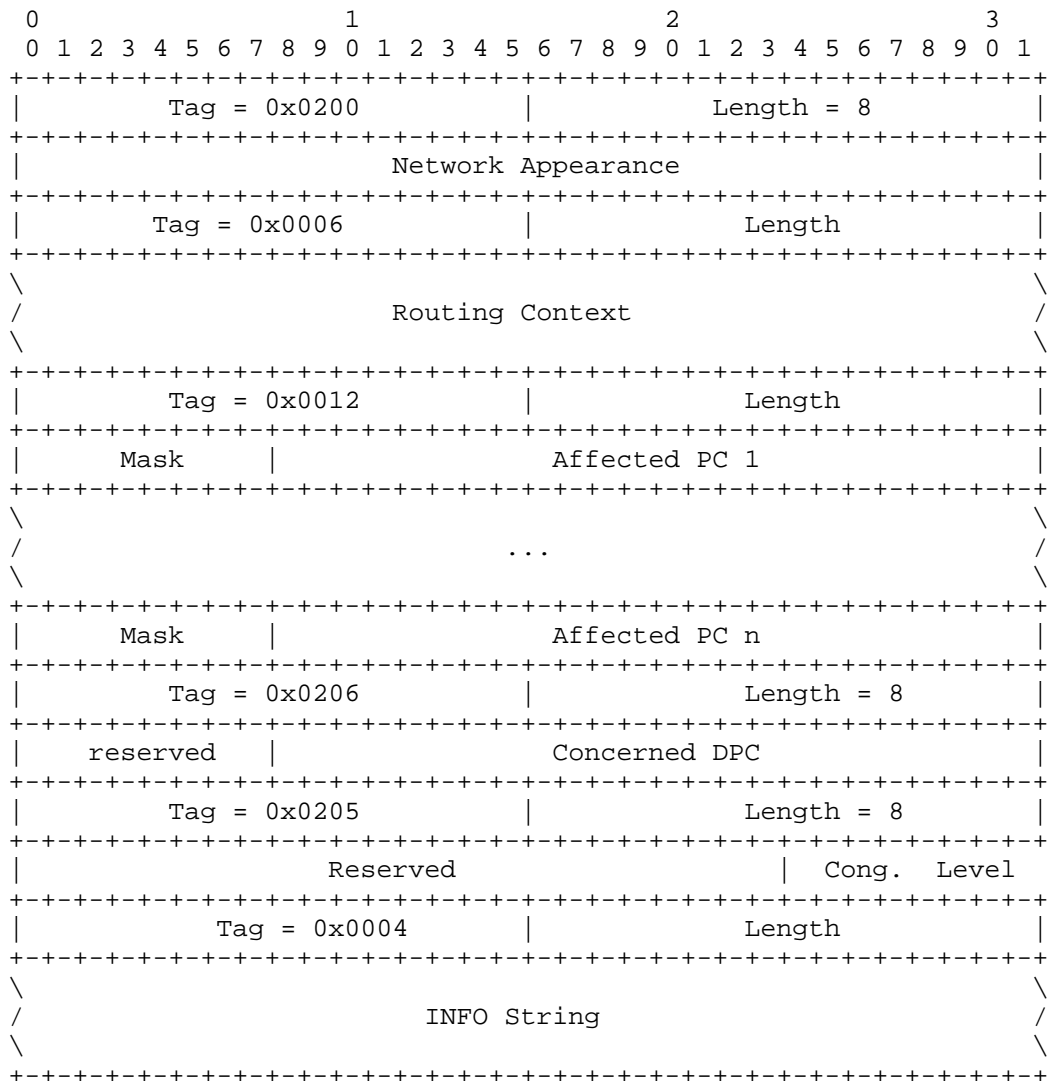

The format and description of the Network Appearance, Routing Context, Affected Point Code, and INFO String parameters are the same as for the DUNA message (see Section 3.4.1).

The Affected Point Code parameter can be used to indicate congestion of multiple destinations or ranges of destinations.

Concerned Destination: 32 bits

The optional Concerned Destination parameter is only used if the SCON message is sent from an ASP to the SGP. It contains the point code of the originator of the message that triggered the SCON message. The Concerned Destination parameter contains one Concerned Destination Point Code field, a three-octet parameter to allow for 14-, 16-, and 24-bit binary formatted SS7 Point Codes. A Concerned Point Code that is less than 24 bits is padded on the left to the 24-bit boundary. Any resulting Transfer Controlled (TFC) message from the SG is sent to the Concerned Point Code using the single Affected DPC contained in the SCON message to populate the (affected) Destination field of the TFC message

Congested Indications: 32 bits

The optional Congestion Indications parameter contains a Congestion Level field. This optional parameter is used to communicate congestion levels in national MTP networks with multiple congestion thresholds, such as in ANSI MTP3. For MTP congestion methods without multiple congestion levels (e.g., the ITU international method) the parameter is not included.

Congestion Level field: 8 bits (unsigned integer)

The Congestion Level field, associated with all of the Affected DPC(s) in the Affected Destinations parameter, contains one of the following values:

- | | |
|---|----------------------------|
| 0 | No Congestion or Undefined |
| 1 | Congestion Level 1 |
| 2 | Congestion Level 2 |
| 3 | Congestion Level 3 |

The congestion levels are defined in the congestion method in the appropriate national MTP recommendations [7,8].

3.4.5. Destination User Part Unavailable (DUPU)

The DUPU message is used by an SGP to inform concerned ASPs that a remote peer MTP3-User Part (e.g., ISUP or SCCP) at an SS7 node is unavailable.

The DUPU message contains the following parameters:

Network Appearance	Optional
Routing Context	Conditional
Affected Point Code	Mandatory
User/Cause	Mandatory
INFO String	Optional

The format for DUPU message parameters is as follows:

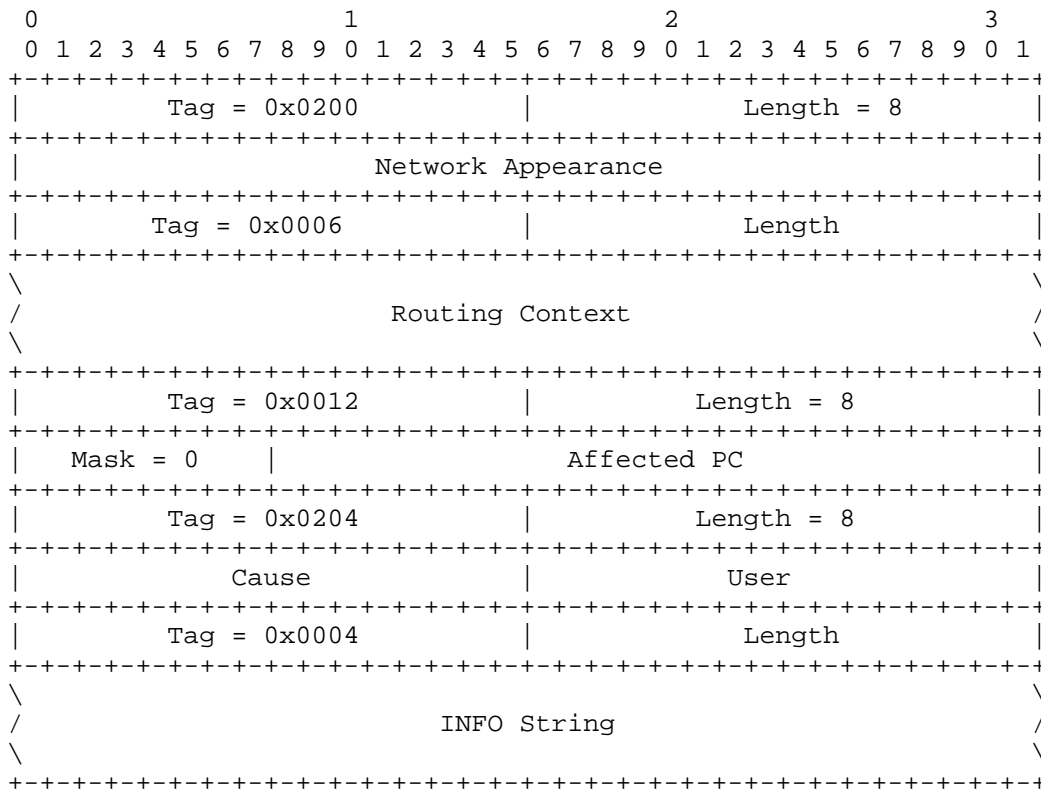

User/Cause: 32 bits

The Unavailability Cause and MTP3-User Identity fields, associated with the Affected PC in the Affected Point Code parameter, are encoded as follows:

Unavailability Cause field: 16 bits (unsigned integer)

The Unavailability Cause parameter provides the reason for the unavailability of the MTP3-User. The valid values for the Unavailability Cause parameter are shown in the following table. The values agree with those provided in the SS7 MTP3 User Part Unavailable message. Depending on the MTP3 protocol used in the Network Appearance, additional values may be used; the specification of the relevant MTP3 protocol variant/version recommendation is definitive.

0	Unknown
1	Unequipped Remote User
2	Inaccessible Remote User

MTP3-User Identity field: 16 bits (unsigned integer)

The MTP3-User Identity describes the specific MTP3-User that is unavailable (e.g., ISUP, SCCP, etc.). Some of the valid values for the MTP3-User Identity are shown below. The values align with those provided in the SS7 MTP3 User Part Unavailable message and Service Indicator. Depending on the MTP3 protocol variant/version used in the Network Appearance, additional values may be used. The relevant MTP3 protocol variant/version recommendation is definitive.

0 to 2	Reserved
3	SCCP
4	TUP
5	ISUP
6 to 8	Reserved
9	Broadband ISUP
10	Satellite ISUP
11	Reserved
12	AAL type 2 Signalling
13	Bearer Independent Call Control (BICC)
14	Gateway Control Protocol
15	Reserved

The format and description of the Affected Point Code parameter are the same as for the DUNA message (see Section 3.4.1.) except that the Mask field is not used and only a single Affected DPC is

included. Ranges and lists of Affected DPCs cannot be signaled in a DUPU message, but this is consistent with UPU operation in the SS7 network. The Affected Destinations parameter in an MTP3 User Part Unavailable message (UPU) received by an SGP from the SS7 network contains only one destination.

The format and description of the Network Appearance, Routing Context, and INFO String parameters are the same as for the DUNA message (see Section 3.4.1).

3.4.6. Destination Restricted (DRST)

The DRST message is optionally sent from the SGP to all concerned ASPs to indicate that the SG has determined that one or more SS7 destinations are now restricted from the point of view of the SG, or in response to a DAUD message, if appropriate. The M3UA layer at the ASP is expected to send traffic to the affected destination via an alternate SG with a route of equal priority, but only if such an alternate route exists and is available. If the affected destination is currently considered unavailable by the ASP, The MTP3-User should be informed that traffic to the affected destination can be resumed. In this case, the M3UA layer should route the traffic through the SG initiating the DRST message.

This message is optional for the SG to send, and it is optional for the ASP to act on any information received in the message. It is for use in the "STP" case described in Section 1.4.1.

The DRST message contains the following parameters:

Network Appearance	Optional
Routing Context	Conditional
Affected Point Code	Mandatory
INFO String	Optional

The format and description of the Network Appearance, Routing Context, Affected Point Code, and INFO String parameters are the same as for the DUNA message (see Section 3.4.1).

3.5. ASP State Maintenance (ASPSM) Messages

3.5.1. ASP Up

The ASP Up message is used to indicate to a remote M3UA peer that the adaptation layer is ready to receive any ASPSM/ASPTM messages for all Routing Keys that the ASP is configured to serve.

The ASP Up message contains the following parameters:

ASP Identifier	Optional
INFO String	Optional

The format for ASP Up message parameters is as follows:

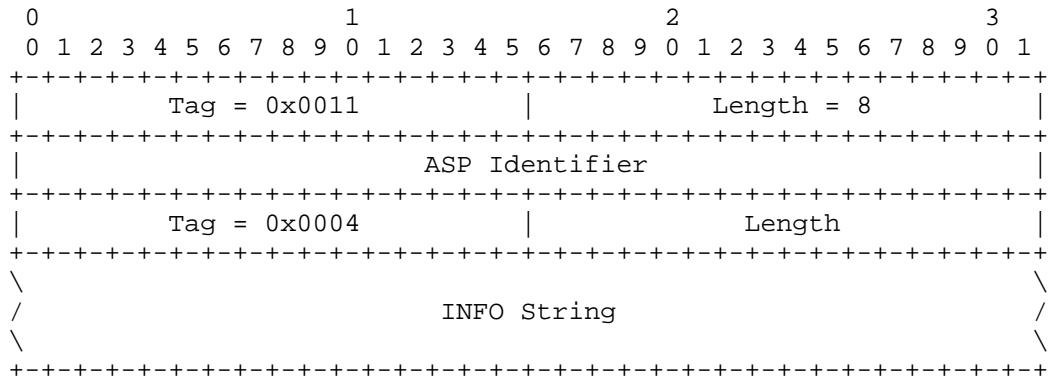

ASP Identifier: 32-bit unsigned integer

The optional ASP Identifier parameter contains a unique value that is locally significant among the ASPs that support an AS. The SGP should save the ASP Identifier to be used, if necessary, with the Notify message (see Section 3.8.2).

The format and description of the optional INFO String parameter are the same as for the DUNA message (see Section 3.4.1).

3.5.2. ASP Up Acknowledgement (ASP Up Ack)

The ASP UP Ack message is used to acknowledge an ASP Up message received from a remote M3UA peer.

The ASP Up Ack message contains the following parameters:

ASP Identifier	Optional
INFO String	Optional

The format for ASP Up Ack message parameters is as follows:

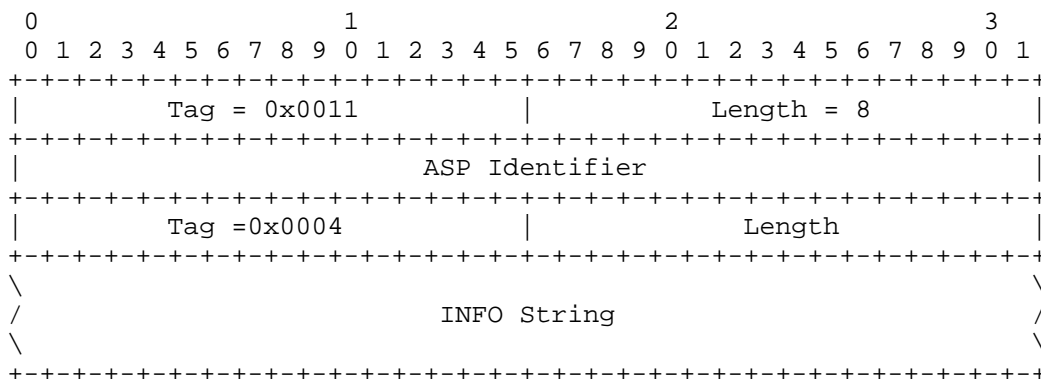

The optional ASP Identifier parameter is specifically useful for IPSP communication. In that case, the IPSP answering the ASP Up message MAY include its own ASP Identifier value.

The format and description of the optional INFO String parameter are the same as for the DUNA message (see Section 3.4.1). The INFO String in an ASP Up Ack message is independent from the INFO String in the ASP Up message (i.e., it does not have to echo back the INFO String received).

3.5.3. ASP Down

The ASP Down message is used to indicate to a remote M3UA peer that the adaptation layer is NOT ready to receive DATA, SSNM, RKM, or ASPTM messages.

The ASP Down message contains the following parameter:

INFO String Optional

The format for the ASP Down message parameters is as follows:

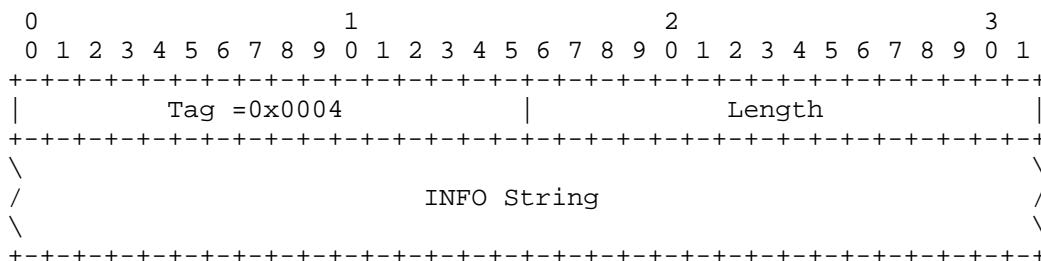

The format and description of the optional INFO String parameter are the same as for the DUNA message (see Section 3.4.1).

3.5.4. ASP Down Acknowledgement (ASP Down Ack)

The ASP Down Ack message is used to acknowledge an ASP Down message received from a remote M3UA peer.

The ASP Down Ack message contains the following parameter:

INFO String Optional

The format for the ASP Down Ack message parameters is as follows:

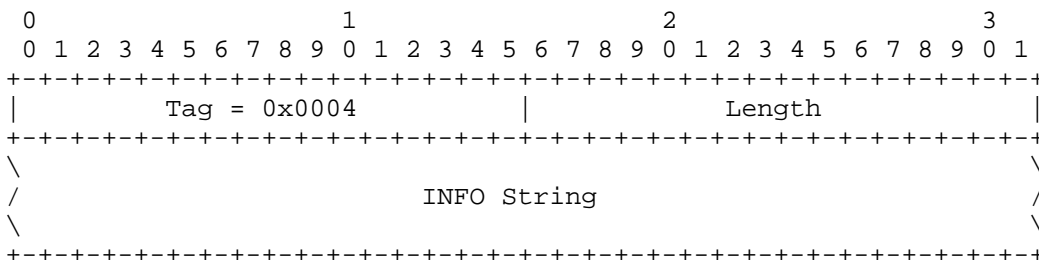

The format and description of the optional INFO String parameter are the same as for the DUNA message (See Section 3.4.1).

The INFO String in an ASP Down Ack message is independent from the INFO String in the ASP Down message (i.e., it does not have to echo back the INFO String received).

3.5.5. Heartbeat (BEAT)

The BEAT message is optionally used to ensure that the M3UA peers are still available to each other. It is recommended for use when the M3UA runs over a transport layer other than the SCTP, which has its own heartbeat.

The BEAT message contains the following parameter:

Heartbeat Data Optional

The format for the BEAT message is as follows:

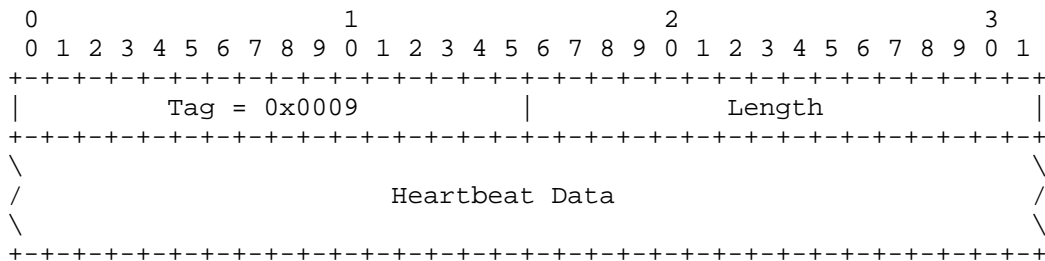

The Heartbeat Data parameter contents are defined by the sending node. The Heartbeat Data could include, for example, a Heartbeat Sequence Number and/or Timestamp. The receiver of a BEAT message does not process this field, as it is only of significance to the sender. The receiver MUST respond with a BEAT Ack message.

3.5.6. Heartbeat Acknowledgement (BEAT Ack)

The BEAT Ack message is sent in response to a received BEAT message. It includes all the parameters of the received BEAT message, without any change.

3.6. Routing Key Management (RKM) Messages [Optional]

3.6.1. Registration Request (REG REQ)

The REG REQ message is sent by an ASP to indicate to a remote M3UA peer that it wishes to register one or more given Routing Keys with the remote peer. Typically, an ASP would send this message to an SGP and expect to receive a REG RSP message in return with an associated Routing Context value.

The REG REQ message contains the following parameter:

Routing Key	Mandatory
-------------	-----------

One or more Routing Key parameters MAY be included. The format for the REG REQ message is as follows:

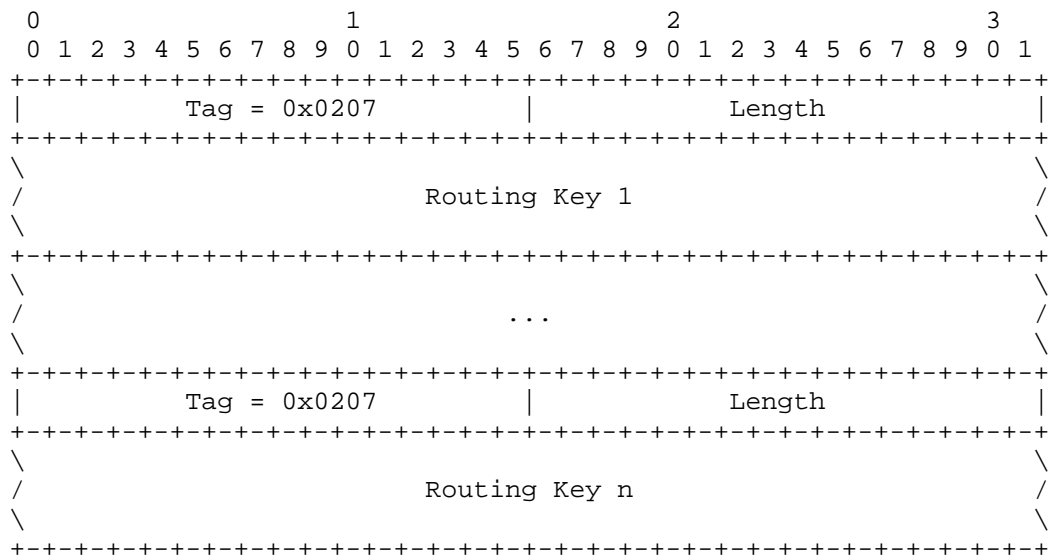

Routing Key: variable length

The Routing Key parameter is mandatory. The sender of this message expects that the receiver of this message will create a Routing Key entry and assign a unique Routing Context value to it, if the Routing Key entry does not already exist.

The Routing Key parameter may be present multiple times in the same message. This is used to allow the registration of multiple Routing Keys in a single message.

The format of the Routing Key parameter is as follows:

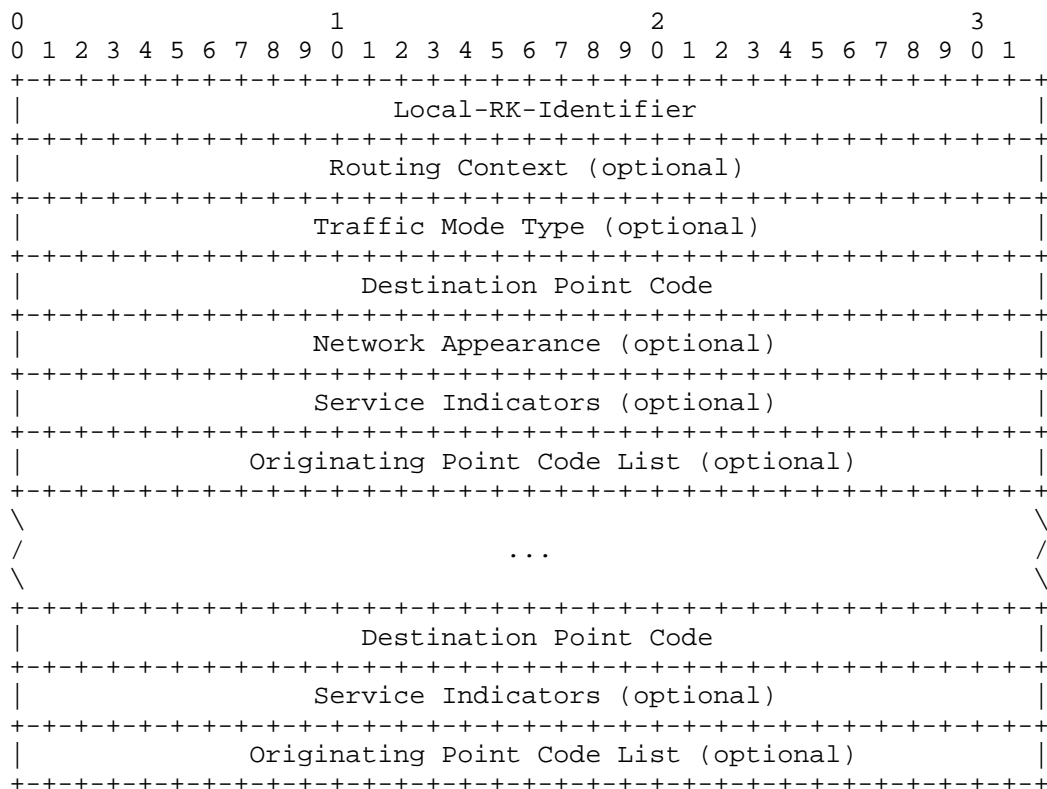

Note: The Destination Point Code, Service Indicators, and Originating Point Code List parameters MAY be repeated as a grouping within the Routing Key parameter, in the structure shown above.

Local-RK-Identifier: 32-bit unsigned integer

The mandatory Local-RK-Identifier field is used to uniquely identify the registration request. The Identifier value is assigned by the ASP and used to correlate the response in an REG RSP message with the original registration request. The Identifier value must remain unique until the REG RSP message is received.

The format of the Local-RK-Identifier field is as follows:

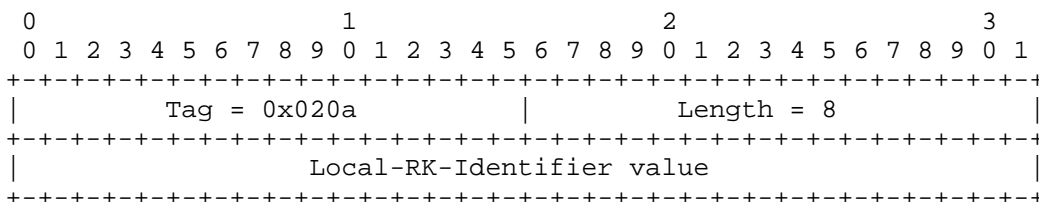

Traffic Mode Type: 32-bit (unsigned integer)

The optional Traffic Mode Type parameter identifies the traffic mode of operation of the ASP(s) within an Application Server. The format of the Traffic Mode Type Identifier is as follows:

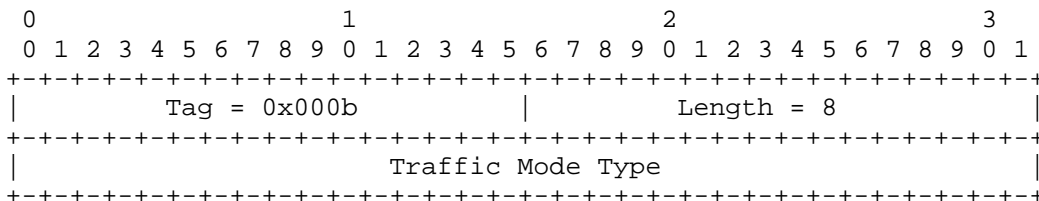

The valid values for Traffic Mode Type are shown in the following table:

- 1 Override
- 2 Loadshare
- 3 Broadcast

Destination Point Code

The Destination Point Code parameter is mandatory, and it identifies the Destination Point Code of incoming SS7 traffic for which the ASP is registering. For an alias point code configuration, the DPC parameter would be repeated for each point code. The format is the same as described for the Affected Destination parameter in the DUNA message (see Section 3.4.1). Its format is:

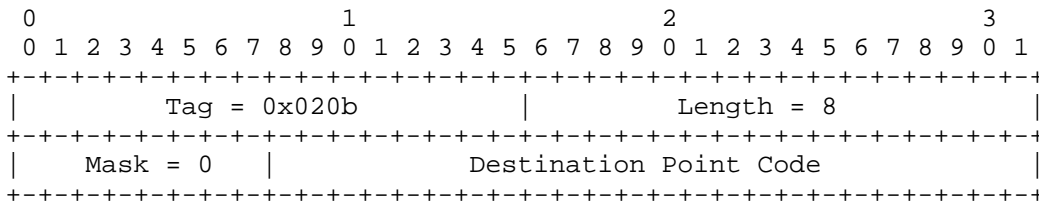

Network Appearance

The optional Network Appearance parameter field identifies the SS7 network context for the Routing Key, and it has the same format as in the DATA message (see Section 3.3.1) with the exception that it does not have to be the first parameter in the message. If the Network Appearance is not specified and the Routing Key applies to all Network Appearances, then this Routing Key MUST be the only one registered for the association; that is, Routing Context is implied, and DATA and SSNM messages are discriminated on Network Appearance rather than on Routing Context. Where Network Appearance is not specified and there is only one Network Appearance, then Network Appearance is implied. Its format is:

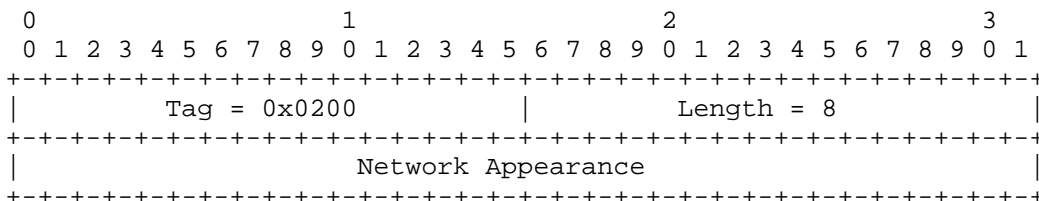

Service Indicators (SI): n X 8-bit integers

The optional SI [7,8] field contains one or more Service Indicators from the values described in the MTP3-User Identity field of the DUPU message. The absence of the SI parameter in the Routing Key indicates the use of any SI value, excluding of course MTP management. Where an SI parameter does not contain a multiple of four SIs, the parameter is padded out to 32-byte alignment.

The SI format is:

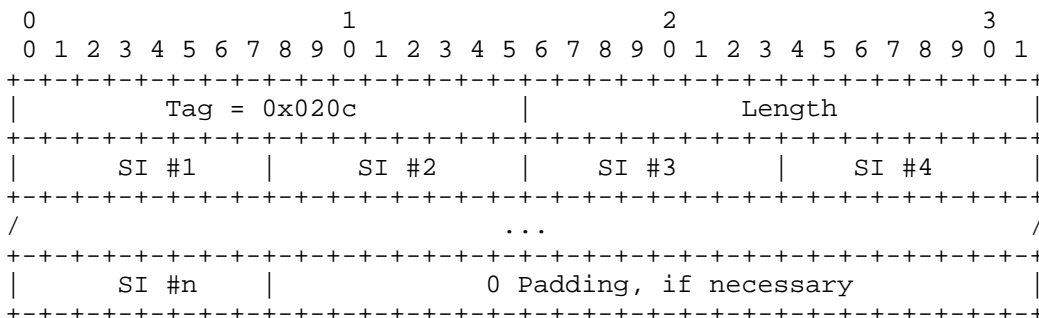

OPC List

The Originating Point Code List parameter contains one or more SS7 OPC entries, and its format is the same as for the Destination Point Code parameter. The absence of the OPC List parameter in the Routing Key indicates the use of any OPC value.

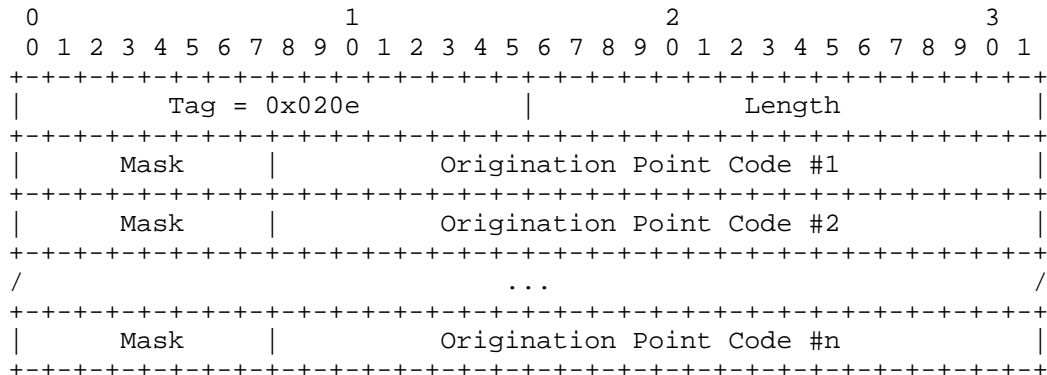

3.6.2. Registration Response (REG RSP)

The REG RSP message is used as a response to the REG REQ message from a remote M3UA peer. It contains indications of success/failure for registration requests and returns a unique Routing Context value for successful registration requests, to be used in subsequent M3UA Traffic Management protocol.

The REG RSP message contains the following parameter:

Registration Result Mandatory

One or more Registration Result parameters MUST be included. The format for the REG RSP message is as follows:

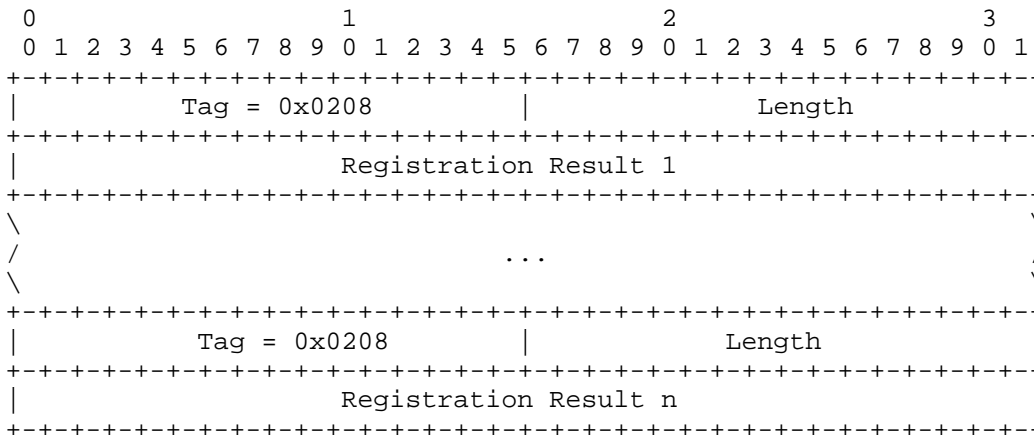

Registration Results

The Registration Result parameter contains the registration result for a single Routing Key in an REG REQ message. The number of results in a single REG RSP message MUST be anywhere from one to the total number of number of Routing Key parameters found in the corresponding REG REQ message. Where multiple REG RSP messages are used in reply to REG REQ message, a specific result SHOULD be in only one REG RSP message. The format of each result is as follows:

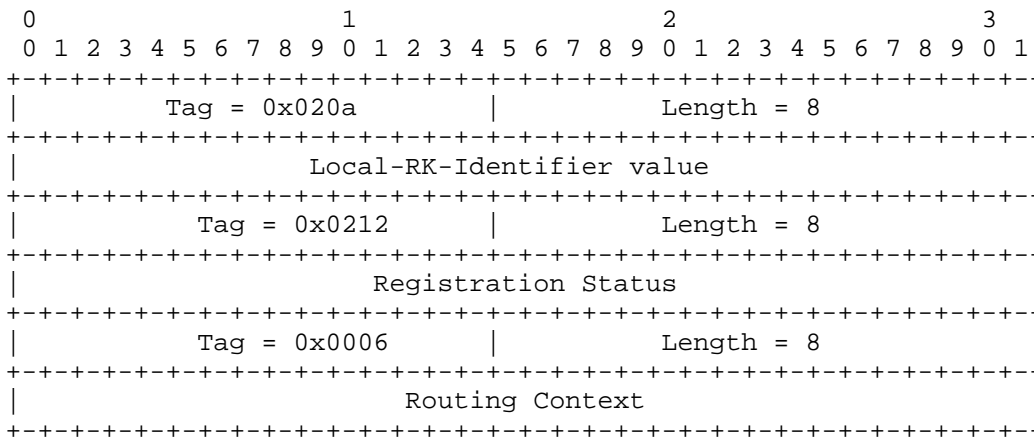

Local-RK-Identifier: 32-bit integer

The Local-RK-Identifier contains the same value as found in the matching Routing Key parameter found in the REG REQ message (See Section 3.6.1).

Registration Status: 32-bit integer

The Registration Result Status field indicates the success or the reason for failure of a registration request.

Its values may be:

0	Successfully Registered
1	Error - Unknown
2	Error - Invalid DPC
3	Error - Invalid Network Appearance
4	Error - Invalid Routing Key
5	Error - Permission Denied
6	Error - Cannot Support Unique Routing
7	Error - Routing Key not Currently Provisioned
8	Error - Insufficient Resources
9	Error - Unsupported RK parameter Field
10	Error - Unsupported/Invalid Traffic Handling Mode
11	Error - Routing Key Change Refused
12	Error - Routing Key Already Registered

Routing Context: 32-bit integer

The Routing Context field contains the Routing Context value for the associated Routing Key if the registration was successful. It is set to "0" if the registration was not successful.

3.6.3. Deregistration Request (DEREG REQ)

The DEREG REQ message is sent by an ASP to indicate to a remote M3UA peer that it wishes to deregister a given Routing Key. Typically, an ASP would send this message to an SGP and expects to receive a DEREG RSP message in return with the associated Routing Context value.

The DEREG REQ message contains the following parameters:

Routing Context	Mandatory
-----------------	-----------

The format for the DEREG REQ message is as follows:

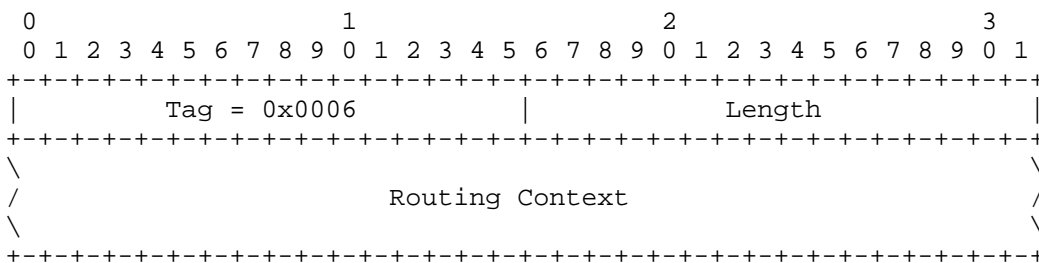

Routing Context: n X 32-bit integers

The Routing Context parameter contains (a list of) integers indexing the Application Server traffic that the sending ASP is currently registered to receive from the SGP but now wishes to deregister.

3.6.4. Deregistration Response (DEREG RSP)

The DEREG RSP message is used as a response to the DEREG REQ message from a remote M3UA peer.

The DEREG RSP message contains the following parameter:

Deregistration Result Mandatory

One or more Deregistration Result parameters MUST be included. The format for the DEREG RSP message is as follows:

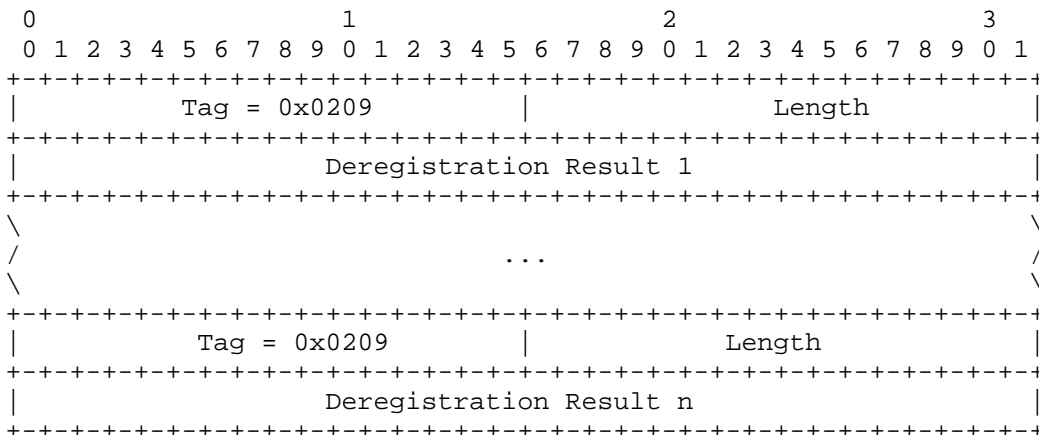

Deregistration Results

The Deregistration Result parameter contains the deregistration status for a single Routing Context in a DEREG REQ message. The number of results in a single DEREG RSP message MAY be anywhere from one to the total number of number of Routing Context values found in the corresponding DEREG REQ message.

Where multiple DEREG RSP messages are used in reply to DEREG REQ message, a specific result SHOULD be in only one DEREG RSP message. The format of each result is as follows:

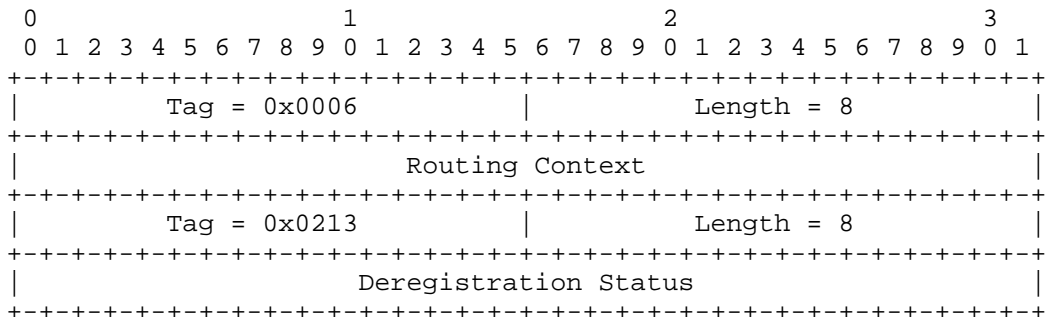

Routing Context: 32-bit integer

The Routing Context field contains the Routing Context value of the matching Routing Key to deregister, as found in the DEREG REQ message.

Deregistration Status: 32-bit integer

The Deregistration Result Status field indicates the success or the reason for failure of the deregistration.

Its values may be:

- 0 Successfully Deregistered
- 1 Error - Unknown
- 2 Error - Invalid Routing Context
- 3 Error - Permission Denied
- 4 Error - Not Registered
- 5 Error - ASP Currently Active for Routing Context

3.7. ASP Traffic Maintenance (ASPTM) Messages

3.7.1. ASP Active

The ASP Active message is sent by an ASP to indicate to a remote M3UA peer that it is ready to process signalling traffic for a particular Application Server. The ASP Active message affects only the ASP state for the Routing Keys identified by the Routing Contexts, if present.

The ASP Active message contains the following parameters:

Traffic Mode Type	Optional
Routing Context	Optional
INFO String	Optional

The format for the ASP Active message is as follows:

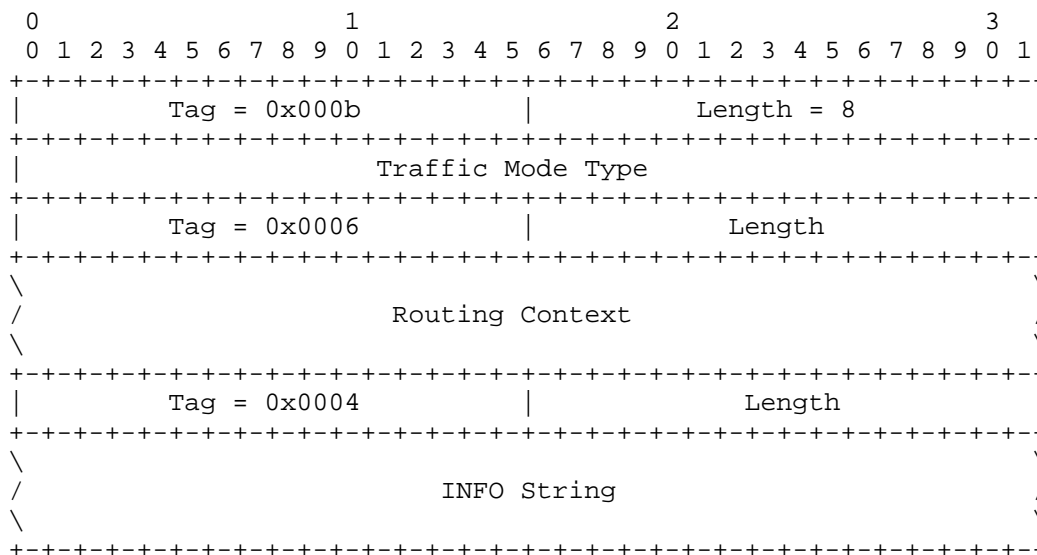

Traffic Mode Type: 32-bit (unsigned integer)

The Traffic Mode Type parameter identifies the traffic mode of operation of the ASP within an AS. The valid values for Traffic Mode Type are shown in the following table:

1	Override
2	Loadshare
3	Broadcast

Within a particular Routing Context, Override, Loadshare, and Broadcast SHOULD NOT be mixed. The Override value indicates that the ASP is operating in Override mode, in which the ASP takes over all traffic in an Application Server (i.e., primary/backup operation), overriding any currently active ASPs in the AS. In Loadshare mode, the ASP will share in the traffic distribution with any other currently active ASPs. In Broadcast mode, the ASP will receive the same messages as any other currently active ASP.

Routing Context: n X 32-bit integers

The optional Routing Context parameter contains (a list of) integers indexing the Application Server traffic that the sending ASP is configured/registered to receive.

There is a one-to-one relationship between an index entry and an SGP Routing Key or AS Name. Because an AS can only appear in one Network Appearance, the Network Appearance parameter is not required in the ASP Active message.

An Application Server Process may be configured to process traffic for more than one logical Application Server. From the perspective of an ASP, a Routing Context defines a range of signalling traffic that the ASP is currently configured to receive from the SGP. For example, an ASP could be configured to support signalling for multiple MTP3-Users, identified by separate SS7 DPC/OPC/SI ranges.

The format and description of the optional INFO String parameter are the same as for the DUNA message (see Section 3.4.1).

3.7.2. ASP Active Acknowledgement (ASP Active Ack)

The ASP Active Ack message is used to acknowledge an ASP Active message received from a remote M3UA peer.

The ASP Active Ack message contains the following parameters:

Traffic Mode Type	Optional
Routing Context	Optional
INFO String	Optional

The format for the ASP Active Ack message is as follows:

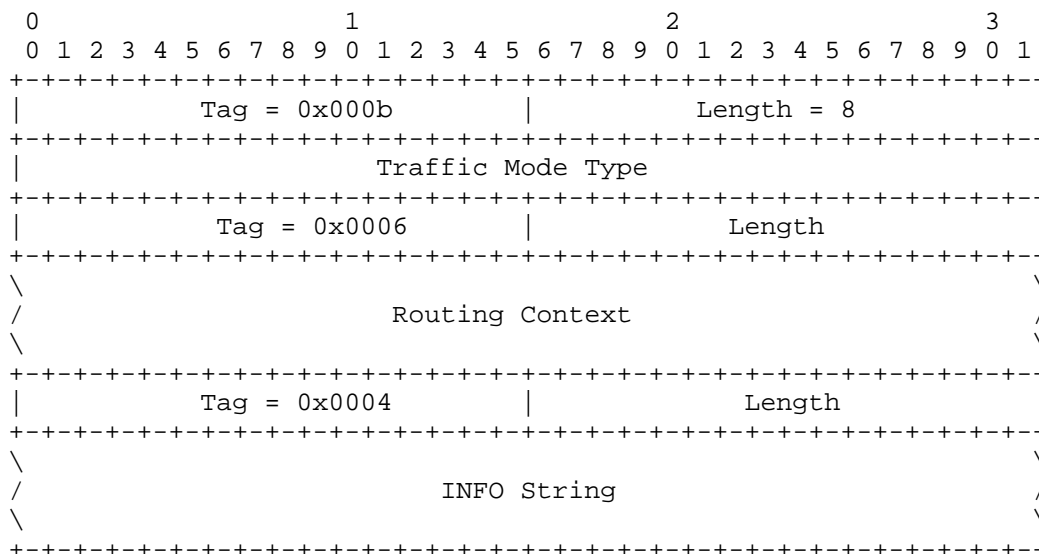

The format and description of the optional INFO String parameter are the same as for the DUNA message (see Section 3.4.1).

The INFO String in an ASP Active Ack message is independent from the INFO String in the ASP Active message (i.e., it does not have to echo back the INFO String received).

The format of the Traffic Mode Type and Routing Context parameters is the same as for the ASP Active message. (See Section 3.7.1.)

3.7.3. ASP Inactive

The ASP Inactive message is sent by an ASP to indicate to a remote M3UA peer that it is no longer an active ASP to be used from within a list of ASPs. The ASP Inactive message affects only the ASP state in the Routing Keys identified by the Routing Contexts, if present.

The ASP Inactive message contains the following parameters:

- Routing Context Optional
- INFO String Optional

The format for the ASP Inactive message parameters is as follows:

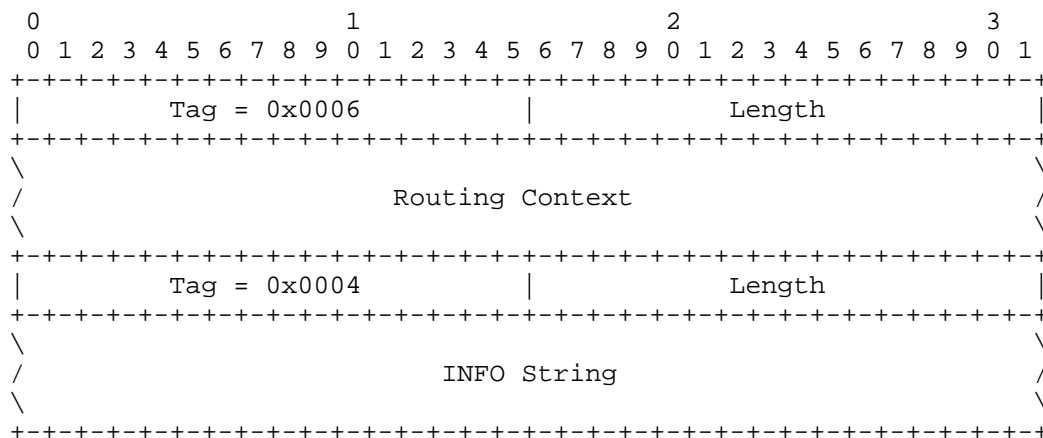

The format and description of the optional Routing Context and INFO String parameters are the same as for the ASP Active message (see Section 3.5.5.)

3.7.4. ASP Inactive Acknowledgement (ASP Inactive Ack)

The ASP Inactive Ack message is used to acknowledge an ASP Inactive message received from a remote M3UA peer.

The ASP Inactive Ack message contains the following parameters:

- Routing Context Optional
- INFO String Optional

The format for the ASP Inactive Ack message is as follows:

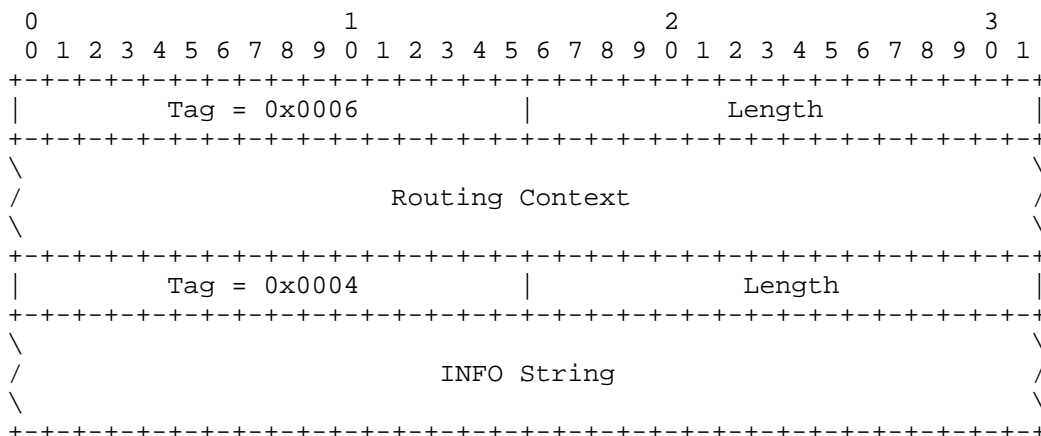

The format and description of the optional INFO String parameter are the same as for the DUNA message (see Section 3.4.1).

The INFO String in an ASP Inactive Ack message is independent from the INFO String in the ASP Inactive message (i.e., it does not have to echo back the INFO String received).

The format of the Routing Context parameter is the same as for the ASP Inactive message. (see Section 3.7.3.)

3.8. Management (MGMT) Messages

3.8.1. Error

The Error message is used to notify a peer of an error event associated with an incoming message. For example, the message type might be unexpected given the current state, or a parameter value might be invalid. Error messages MUST NOT be generated in response to other Error messages.

The Error message contains the following parameters:

Error Code	Mandatory
Routing Context	Mandatory*
Network Appearance	Mandatory*
Affected Point Code	Mandatory*
Diagnostic Information	Conditional

* Only mandatory for specific Error Codes.

The format for the Error message is as follows:

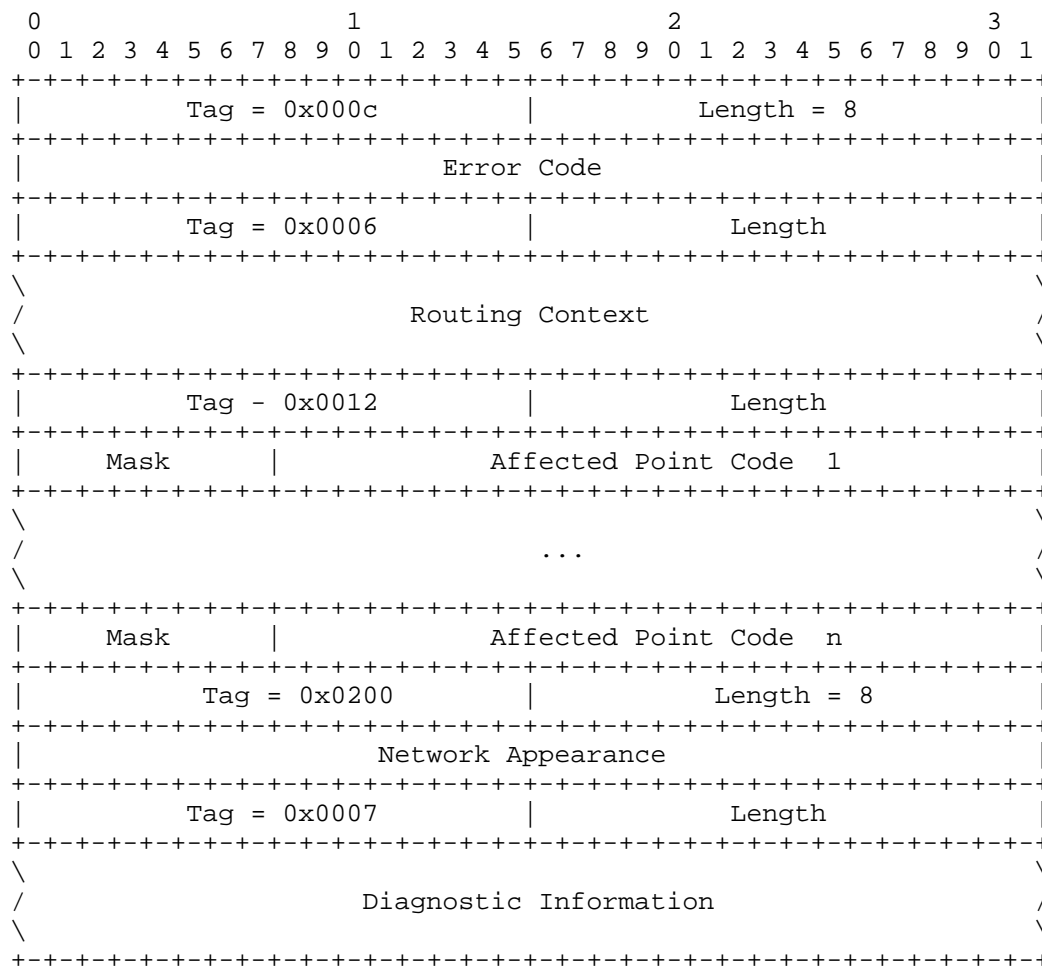

Error Code: 32 bits (unsigned integer)

The Error Code parameter indicates the reason for the Error Message. The Error parameter value can be one of the following values:

0x01	Invalid Version
0x02	Not Used in M3UA
0x03	Unsupported Message Class
0x04	Unsupported Message Type
0x05	Unsupported Traffic Mode Type
0x06	Unexpected Message

0x07	Protocol Error
0x08	Not Used in M3UA
0x09	Invalid Stream Identifier
0x0a	Not Used in M3UA
0x0b	Not Used in M3UA
0x0c	Not Used in M3UA
0x0d	Refused - Management Blocking
0x0e	ASP Identifier Required
0x0f	Invalid ASP Identifier
0x10	Not Used in M3UA
0x11	Invalid Parameter Value
0x12	Parameter Field Error
0x13	Unexpected Parameter
0x14	Destination Status Unknown
0x15	Invalid Network Appearance
0x16	Missing Parameter
0x17	Not Used in M3UA
0x18	Not Used in M3UA
0x19	Invalid Routing Context
0x1a	No Configured AS for ASP

The "Invalid Version" error is sent if a message with an unsupported version is received. The receiving end responds with an Error message, indicating the version the receiving node supports, and notifies layer management.

The "Unsupported Message Class" error is sent if a message with an unexpected or unsupported Message Class is received. For this error, the Diagnostic Information parameter MUST be included with the first 40 octets of the offending message.

The "Unsupported Message Type" error is sent if a message with an unexpected or unsupported Message Type is received. For this error, the Diagnostic Information parameter MUST be included with the first 40 octets of the offending message.

The "Unsupported Traffic Mode Type" error is sent by a SGP if an ASP sends an ASP Active message with an unsupported Traffic Mode Type or a Traffic Mode Type that is inconsistent with the presently configured mode for the Application Server. An example would be a case in which the SGP did not support loadsharing.

The "Unexpected Message" error MAY be sent if a defined and recognized message is received that is not expected in the current state (in some cases, the ASP may optionally silently discard the message and not send an Error message). For example, silent discard is used by an ASP if it received a DATA message from an SGP while it was in the ASP-INACTIVE state. If the Unexpected message contained

Routing Contexts, the Routing Contexts SHOULD be included in the Error message.

The "Protocol Error" error is sent for any protocol anomaly (i.e., receipt of a parameter that is syntactically correct but unexpected in the current situation).

The "Invalid Stream Identifier" error is sent if a message is received on an unexpected SCTP stream (e.g., a Management message was received on a stream other than "0").

The "Refused - Management Blocking" error is sent when an ASP Up or ASP Active message is received and the request is refused for management reasons (e.g., management lockout). If this error is in response to an ASP Active message, the Routing Context(s) in the ASP Active message SHOULD be included in the Error message.

The "ASP Identifier Required" error is sent by an SGP in response to an ASP Up message that does not contain an ASP Identifier parameter when the SGP requires one. The ASP SHOULD resend the ASP Up message with an ASP Identifier.

The "Invalid ASP Identifier" error is sent by an SGP in response to an ASP Up message with an invalid (i.e., non-unique) ASP Identifier.

The "Invalid Parameter Value" error is sent if a message is received with an invalid parameter value (e.g., a DUPU message was received with a Mask value other than "0").

The "Parameter Field Error" would be sent if a message is received with a parameter having a wrong length field.

The "Unexpected Parameter" error would be sent if a message contains an invalid parameter.

The "Destination Status Unknown" error MAY be sent if a DAUD is received at an SG enquiring of the availability/congestion status of a destination and the SG does not wish to provide the status (e.g., the sender is not authorized to know the status). For this error, the invalid or unauthorized Point Code(s) MUST be included along with the Network Appearance and/or Routing Context associated with the Point Code(s).

The "Invalid Network Appearance" error is sent by an SGP if an ASP sends a message with an invalid (unconfigured) Network Appearance value. For this error, the invalid (unconfigured) Network Appearance MUST be included in the Network Appearance parameter.

The "Missing Parameter" error would be sent if a mandatory parameter were not included in a message. This error is also sent if a conditional parameter is not included in the message but is required in the context of the received message.

The "Invalid Routing Context" error is sent if a message is received from a peer with an invalid (unconfigured) Routing Context value. For this error, the invalid Routing Context(s) MUST be included in the Error message.

The "No Configured AS for ASP" error is sent if a message is received from a peer without a Routing Context parameter and it is not known by configuration data which Application Servers are referenced.

Diagnostic Information: variable length

When included, the optional Diagnostic Information can be any information germane to the error condition, to assist in identification of the error condition. The Diagnostic Information SHOULD contain the offending message. A Diagnostic Information parameter with a zero length parameter is not considered an error (this means that the Length field in the TLV will be set to 4).

3.8.2. Notify

The Notify message used to provide an autonomous indication of M3UA events to an M3UA peer.

The Notify message contains the following parameters:

Status	Mandatory
ASP Identifier	Conditional
Routing Context	Optional
INFO String	Optional

The format for the Notify message is as follows:

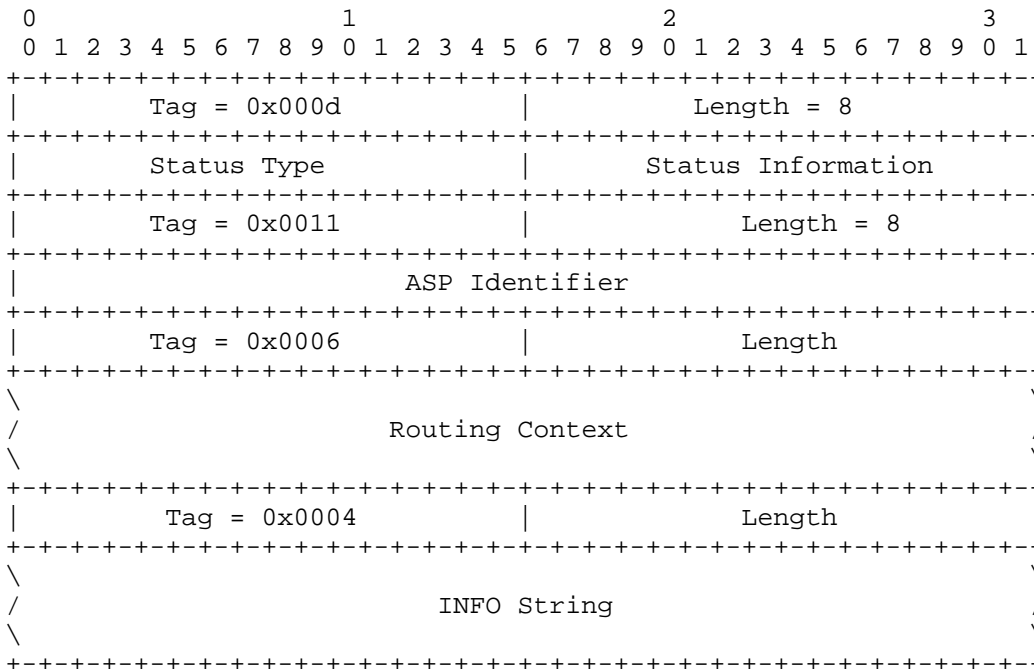

Status Type: 16 bits (unsigned integer)

The Status Type parameter identifies the type of the Notify message. The following are the valid Status Type values:

- 1 Application Server State Change (AS-State_Change)
- 2 Other

Status Information: 16 bits (unsigned integer)

The Status Information parameter contains more detailed information for the notification, based on the value of the Status Type. If the Status Type is AS-State_Change the following Status Information values are used:

- 1 Reserved
- 2 Application Server Inactive (AS-INACTIVE)
- 3 Application Server Active (AS-ACTIVE)
- 4 Application Server Pending (AS-PENDING)

These notifications are sent from an SGP to an ASP upon a change in status of a particular Application Server. The value reflects the new state of the Application Server.

If the Status Type is Other, then the following Status Information values are defined:

- 1 Insufficient ASP Resources Active in AS
- 2 Alternate ASP Active
- 3 ASP Failure

These notifications are not based on the SGP reporting the state change of an ASP or AS. In the Insufficient ASP Resources case, the SGP is indicating to an ASP_INACTIVE ASP in the AS that another ASP is required to handle the load of the AS (Loadsharing or Broadcast mode). For the Alternate ASP Active case, an ASP is informed when an alternate ASP transitions to the ASP-ACTIVE state in Override mode. The ASP Identifier (if available) of the Alternate ASP MUST be placed in the message. For the ASP Failure case, the SGP is indicating to ASPs in the AS that one of the ASPs has failed. The ASP Identifier (if available) of the failed ASP MUST be placed in the message.

The format and description of the conditional ASP Identifier is the same as for the ASP Up message (see Section 3.5.1). The format and description of the Routing Context and Info String parameters are the same as for the ASP Active message (See Section 3.7.1)

4. Procedures

The M3UA layer needs to respond to various local primitives it receives from other layers, as well as to the messages that it receives from the peer M3UA layer. This section describes the M3UA procedures in response to these events.

4.1. Procedures to Support the M3UA-User

4.1.1. Receipt of Primitives from the M3UA-User

On receiving an MTP-TRANSFER request primitive from an upper layer at an ASP/IPSP, or the nodal interworking function at an SGP, the M3UA layer sends a corresponding DATA message (see Section 3) to its M3UA peer. The M3UA peer receiving the DATA message sends an MTP-TRANSFER indication primitive to the upper layer.

The M3UA message distribution function (see Section 1.4.2.1) determines the Application Server (AS) by comparing the information in the MTP-TRANSFER request primitive with a provisioned Routing Key.

From the list of ASPs within the AS table, an ASP in the ASP-ACTIVE state is selected and a DATA message is constructed and issued on the corresponding SCTP association. If more than one ASP is in the ASP-ACTIVE state (i.e., traffic is to be loadshared across more than one ASP), one of the ASPs in the ASP-ACTIVE state is selected from the list. If the ASPs are in Broadcast Mode, all active ASPs will be selected, and the message will be sent to each of the active ASPs. The selection algorithm is implementation dependent but could, for example, be round robin or based on the SLS or ISUP CIC. The appropriate selection algorithm must be chosen carefully, as it is dependent on application assumptions and understanding of the degree of state coordination between the ASP-ACTIVE ASPs in the AS.

In addition, the message needs to be sent on the appropriate SCTP stream, again taking care to meet the message sequencing needs of the signalling application. DATA messages MUST be sent on an SCTP stream other than stream '0'.

When there is no Routing Key match, or only a partial match, for an incoming SS7 message, a default treatment MAY be specified. Possible solutions are to provide a default Application Server at the SGP that directs all unallocated traffic to a (set of) default ASP(s), or to drop the message and provide a notification to Layer Management in an M-ERROR indication primitive. The treatment of unallocated traffic is implementation dependent.

4.2. Receipt of Primitives from the Layer Management

On receiving primitives from the local Layer Management, the M3UA layer will take the requested action and provide an appropriate response primitive to Layer Management.

An M-SCTP_ESTABLISH request primitive from Layer Management at an ASP or IPSP will initiate the establishment of an SCTP association. The M3UA layer will attempt to establish an SCTP association with the remote M3UA peer by sending an SCTP-ASSOCIATE primitive to the local SCTP layer.

When an SCTP association has been successfully established, the SCTP will send an SCTP-COMMUNICATION_UP notification primitive to the local M3UA layer. At the SGP or IPSP that initiated the request, the M3UA layer will send an M-SCTP_ESTABLISH confirm primitive to Layer Management when the association setup is complete. At the peer M3UA layer, an M-SCTP_ESTABLISH indication primitive is sent to Layer Management upon successful completion of an incoming SCTP association setup.

An M-SCTP_RELEASE request primitive from Layer Management initiates the teardown of an SCTP association. The M3UA layer accomplishes a graceful shutdown of the SCTP association by sending an SCTP-SHUTDOWN primitive to the SCTP layer.

When the graceful shutdown of the SCTP association has been accomplished, the SCTP layer returns an SCTP-SHUTDOWN_COMPLETE notification primitive to the local M3UA layer. At the M3UA Layer that initiated the request, the M3UA layer will send an M-SCTP_RELEASE confirm primitive to Layer Management when the association shutdown is complete. At the peer M3UA Layer, an M-SCTP_RELEASE indication primitive is sent to Layer Management upon abort or successful shutdown of an SCTP association.

An M-SCTP_STATUS request primitive supports a Layer Management query of the local status of a particular SCTP association. The M3UA layer simply maps the M-SCTP_STATUS request primitive to an SCTP-STATUS primitive to the SCTP layer. When the SCTP responds, the M3UA layer maps the association status information to an M-SCTP_STATUS confirm primitive. No peer protocol is invoked.

Similar LM-to-M3UA-to-SCTP and/or SCTP-to-M3UA-to-LM primitive mappings can be described for the various other SCTP Upper Layer primitives in RFC2960 [18], such as INITIALIZE, SET PRIMARY, CHANGE HEARTBEAT, REQUEST HEARTBEAT, GET SRTT REPORT, SET FAILURE THRESHOLD, SET PROTOCOL PARAMETERS, DESTROY SCTP INSTANCE, SEND FAILURE, and NETWORK STATUS CHANGE. Alternatively, these SCTP Upper Layer

primitives (and Status as well) can be considered, for modeling purposes, as a Layer Management interaction directly with the SCTP Layer.

M-NOTIFY indication and M-ERROR indication primitives indicate to Layer Management the notification or error information contained in a received M3UA Notify or Error message, respectively. These indications can also be generated based on local M3UA events.

An M-ASP_STATUS request primitive supports a Layer Management query of the status of a particular local or remote ASP. The M3UA layer responds with the status in an M-ASP_STATUS confirm primitive. No M3UA peer protocol is invoked.

An M-AS_STATUS request supports a Layer Management query of the status of a particular AS. The M3UA responds with an M-AS_STATUS confirm primitive. No M3UA peer protocol is invoked.

M-ASP_UP, M-ASP_DOWN, M-ASP_ACTIVE, and M-ASP_INACTIVE request primitives allow Layer Management at an ASP to initiate state changes. Upon successful completion, a corresponding confirm primitive is provided by the M3UA layer to Layer Management. If an invocation is unsuccessful, an Error indication primitive is provided in the primitive. These requests result in outgoing ASP Up, ASP Down, ASP Active, and ASP Inactive messages to the remote M3UA peer at an SGP or IPSP.

4.2.1. Receipt of M3UA Peer Management Messages

Upon successful state changes resulting from reception of ASP Up, ASP Down, ASP Active, and ASP Inactive messages from a peer M3UA, the M3UA layer MAY invoke corresponding M-ASP_UP, M-ASP_DOWN, M-ASP_ACTIVE, M-ASP_INACTIVE, M-AS_ACTIVE, M-AS_INACTIVE, and M-AS_DOWN indication primitives to the local Layer Management.

M-NOTIFY indication and M-ERROR indication primitives indicate to Layer Management the notification or error information contained in a received M3UA Notify or Error message. These indications can also be generated based on local M3UA events.

All non-Transfer and non-SSNM messages, except BEAT and BEAT Ack, SHOULD be sent with sequenced delivery to ensure ordering. ASPTM messages MAY be sent on one of the streams used to carry the data traffic related to the Routing Context(s), to minimize possible message loss. BEAT and BEAT Ack messages MAY be sent using out-of-order delivery and MAY be sent on any stream.

4.3. AS and ASP/IPSP State Maintenance

The M3UA layer on the SGP maintains the state of each remote ASP, in each Application Server that the ASP is configured to receive traffic, as input to the M3UA message distribution function. Similarly, where IPSPs use M3UA in a point-to-point fashion, the M3UA layer in an IPSP maintains the state of remote IPSPs.

Two IPSP models are defined as follows:

1. IPSP Single Exchange (SE) model. Only a single exchange of ASPTM and ASPSM messages is needed to change the IPSP states. This means that a set of requests from one end and acknowledgements from the other will be enough. The RK must define both sides of the traffic flow. Each exchange of ASPTM or ASPSM messages can be initiated by either IPSP. For this exchange, the initiating IPSP follows the procedures described in Section 4.3.1.
2. IPSP Double Exchange (DE) model. A double exchange of ASPTM and ASPSM messages is normally needed (ASPSM single exchange is optional as a simplification). Each exchange of ASPTM or ASPSM messages can be initiated by either IPSP. The RKs define the traffic to be directed to the peer as in the AS-SG model. Therefore, two different RKs are usually used, one installed on each peer.

When using double exchanges for ASPSM messages, the management of the connection in the two directions is considered independent. This means that connections from IPSP-A to IPSP-B is handled independently of connections from IPSP-B to IPSP-A. Therefore, it could happen that only one of the two directions is activated or closed, while the other remains in the same state as it was.

When using single exchange of ASPSM, what is seen as a simplification, only the activation phase (ASPTM messages) is independent for each of the two directions. In this case, it could happen that the sending of the ASPSM from IPSP-A or IPSP-B could have an effect in the whole communication, as it is defined in the standard SG-AS communication.

Because of these differences, there should be an agreement on the way ASPSM messages are being handled before starting DE-IPSP communication.

In order to ensure interoperability, an M3UA implementation supporting IPSP communication MUST support the IPSP SE model and MAY implement the IPSP DE model.

In Section 4.3.1, ASP/IPSP States are described.

In Section 4.3.2, only the SGP-ASP scenario is described. All of the procedures referring to an AS served by ASPs are also applicable to ASes served by IPSPs.

In Section 4.3.3, only the Management procedures for the SGP-ASP scenario are described. The corresponding Management procedures for IPSPs are directly implied.

The remaining sections contain specific IPSP Considerations subsections.

4.3.1. ASP/IPSP States

The state of each remote ASP/IPSP, in each AS that it is configured to operate, is maintained in the peer M3UA layer (i.e., in the SGP or peer IPSP, respectively). The state of a particular ASP/IPSP in a particular AS changes due to events. The events include:

- * Receipt of messages from the peer M3UA layer at the ASP/IPSP;
- * Receipt of some messages from the peer M3UA layer at other ASPs/IPSPs in the AS (e.g., ASP Active message indicating "Override");
- * Receipt of indications from the SCTP layer; and
- * Local Management intervention.

The ASP/C-IPSP/D-IPSP state transition diagram is shown in Figure 3. The possible states of an ASP/D-IPSP/C-IPSP are:

ASP-DOWN: The remote M3UA peer at the ASP/IPSP is unavailable, and/or the related SCTP association is down. Initially, all ASPs/IPSPs will be in this state. An ASP/IPSP in this state SHOULD NOT be sent any M3UA messages, with the exception of Heartbeat, ASP Down Ack, and Error messages.

ASP-INACTIVE: The remote M3UA peer at the ASP/IPSP is available (and the related SCTP association is up), but application traffic is stopped. In this state, the ASP/IPSP SHOULD NOT be sent any DATA or SSNM messages for the AS for which the ASP/IPSP is inactive.

ASP-ACTIVE: The remote M3UA peer at the ASP/IPSP is available and application traffic is active (for a particular Routing Context or set of Routing Contexts).

SCTP CDI: The SCTP CDI denotes the local SCTP layer's Communication Down Indication to the Upper Layer Protocol (M3UA) on an SGP. The local SCTP layer will send this indication when it detects the loss

of connectivity to the ASP's peer SCTP layer. SCTP CDI is understood as either a SHUTDOWN_COMPLETE notification or a COMMUNICATION_LOST notification from the SCTP layer.

SCTP RI: The local SCTP layer's Restart indication to the upper-layer protocol (M3UA) on an SG. The local SCTP will send this indication when it detects a restart from the peer SCTP layer.

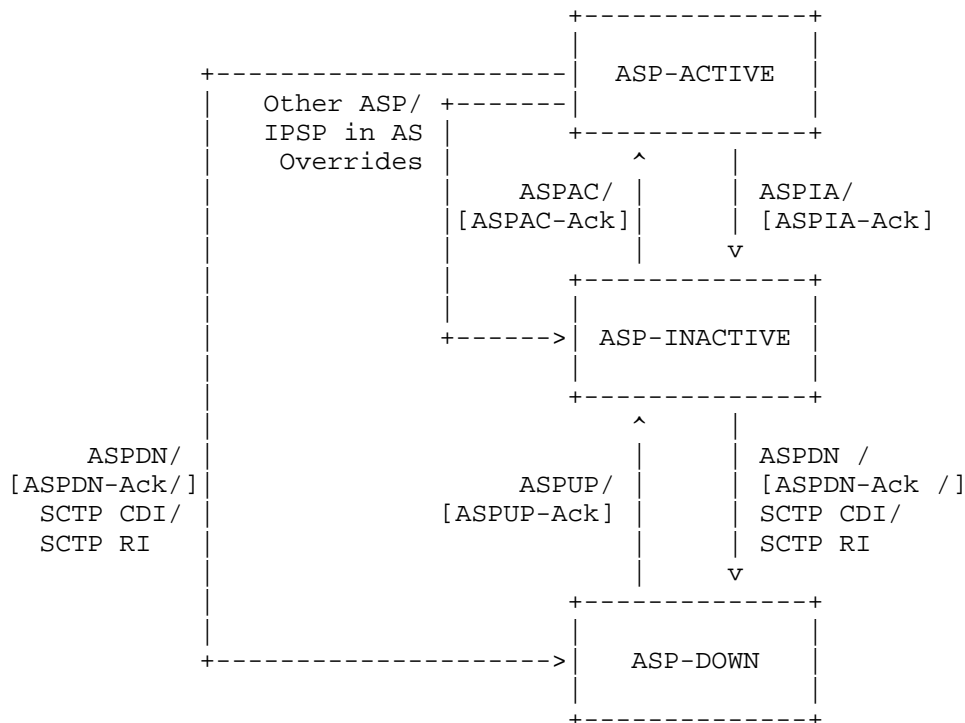

Figure 3: ASP State Transition Diagram, per AS

The transitions are depicted as a result of the reception of ASP*M messages or other events. In some of the transitions, there are some messages in brackets. They mean that for a given node the state transition will be different, depending on its role: whether or not it is generating the ASP*M request message (i.e., ASPUP, ASPAC, ASPIA or ASPDN) or simply receiving it. In a peer-to-peer based architecture (IPSP), this role may change between the peers.

The transitions not in brackets are valid to track the states of ASPs and IPSPs that send an ASP*M request message at the peer node.

The transition in brackets may be used in an ASP or in the IPSP that receives an ASP*M request to track the peer SGP/IPSP states, respectively. There may be an SGP per AS state machine at ASPs.

Then, the transitions in brackets can be used for the IPSP DE model communication (DE-IPSPs) and are related to the special cases when just one ASP*M messages exchange is needed, as follows:

- ASPSM messages. When ASPSM messages are exchanged using only a single exchange (only one request and one acknowledgement).
Example (see Section 5.6.2): Whenever a DE-IPSP is taking the leading role to start communication to a peer DE-IPSP, it sends an ASP Up message to the peer DE-IPSP. The peer MAY consider the initiating DE-IPSPs to be in ASP-INACTIVE state, as it already sent a message, and answer back with ASP Up Ack. Upon receipt of this answer by the initiating DE-IPSP, it also MAY consider the peer to be in ASP-INACTIVE state, since it did respond. Therefore, a second ASP Up message exchange to be started by the peer DE-IPSP could be avoided. In this case, the receipt of ASP Up Ack will turn into a state change.
- ASPTM messages. When sending ASPTM messages to activate/deactivate all the traffic independently of routing keys by not specifying any RC, a single exchange could be sufficient.

4.3.2. AS States

The state of the AS is maintained in the M3UA layer on the SGPs. The state of an AS changes due to events. These events include:

- * ASP state transitions
- * Recovery timer triggers

The possible states of an AS are:

AS-DOWN: The Application Server is unavailable. This state implies that all related ASPs are in ASP-DOWN state for this AS. Initially the AS will be in this state. An Application Server is in the AS-DOWN state when it is removed from a configuration.

AS-INACTIVE: The Application Server is available, but no application traffic is active. One or more related ASPs are in ASP-INACTIVE state, and/or the number of related ASPs in ASP-ACTIVE state has not reached n (n is the number of ASPs required to be in ASP-ACTIVE state before AS can transition to AS-ACTIVE; n = 1 for Override Traffic Mode) for this AS. The recovery timer T(r) is not running or has expired.

AS-ACTIVE: The Application Server is available and application traffic is active. The AS moves to this state after being in AS-INACTIVE and getting n ASPs (n is the number of ASPs required to be in ASP-ACTIVE state before AS can transition to AS-ACTIVE; n = 1 for Override Traffic Mode) in ASP-ACTIVE state or after reaching AS-ACTIVE and keeping one or more ASPs in ASP-ACTIVE state. When one ASP is considered enough to handle traffic (smooth start), the AS in AS-INACTIVE MAY reach the AS-ACTIVE as soon as the first ASP moves to the ASP-ACTIVE state.

AS-PENDING: An active ASP has transitioned to ASP-INACTIVE or ASP DOWN and it was the last remaining active ASP in the AS. A recovery timer T(r) SHOULD be started, and all incoming signalling messages SHOULD be queued by the SGP. If an ASP becomes ASP-ACTIVE before T(r) expires, the AS is moved to the AS-ACTIVE state, and all the queued messages will be sent to the ASP.

If T(r) expires before an ASP becomes ASP-ACTIVE, and the SGP has no alternative, the SGP may stop queuing messages and discard all previously queued messages. The AS will move to the AS-INACTIVE state if at least one ASP is in ASP-INACTIVE; otherwise, it will move to AS-DOWN state.

Figure 4 shows an example AS state machine for the case where the AS/ASP data is preconfigured and is an n+k redundancy model. In other cases where the AS/ASP configuration data is created dynamically, there would be differences in the state machine, especially at creation of the AS.

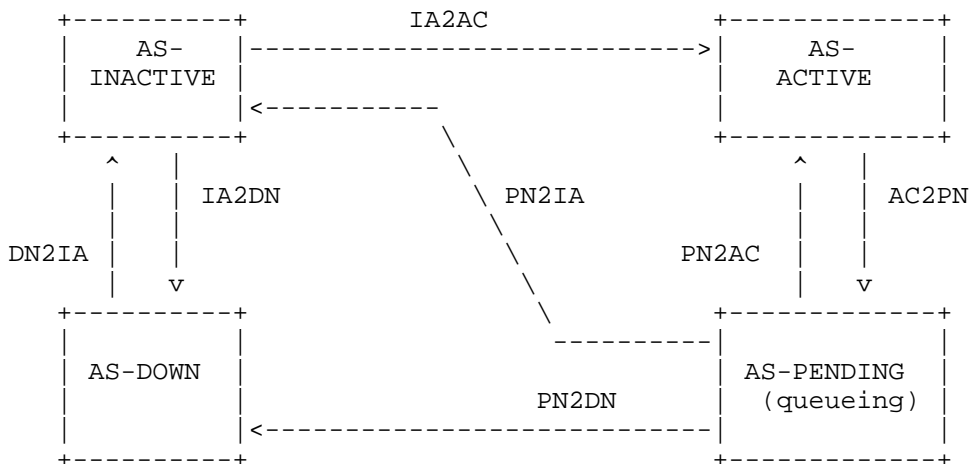

Figure 4: AS State Transition Diagram

DN2IA: One ASP moves from ASP-DOWN to ASP-INACTIVE state.

IA2DN: The last ASP in ASP-INACTIVE moves to ASP-DOWN, causing all the ASPs to be in ASP-DOWN state.

IA2AC: One ASP moves to ASP-ACTIVE, causing the number of ASPs in the ASP-ACTIVE state to be n. In a special case of smooth start, this transition MAY be done when the first ASP moves to ASP-ACTIVE state.

AC2PN: The last ASP in ASP-ACTIVE state moves to ASP-INACTIVE or ASP-DOWN states, causing the number of ASPs in ASP-ACTIVE to drop below 1.

PN2AC: One ASP moves to ASP-ACTIVE.

PN2IA: T(r) expiry; an ASP is in ASP-INACTIVE state but no ASPs are in ASP-ACTIVE state.

PN2DN: T(r) expiry; all the ASPs are in ASP-DOWN state.

An AS becomes AS-ACTIVE right after n ASPs reach the ASP-ACTIVE state during the startup phase (except for smooth start). Once the traffic is flowing, an AS keeps the AS-ACTIVE state till the last ASP turns to another state different from ASP-ACTIVE, avoiding unnecessary traffic disturbances as long as there are ASPs available (this assumes that the system will not always be exposed to the maximum load).

There are other cases where the AS/ASP configuration data is created dynamically. In those cases there would be differences in the state machine, especially at creation of the AS. For example, where the AS/ASP configuration data is not created until Registration of the first ASP, the AS-INACTIVE state is entered directly upon the nth successful REG REQ from an ASP belonging to that AS. Another example is where the AS/ASP configuration data is not created until the nth ASP successfully enters the ASP-ACTIVE state. In this latter case, the AS-ACTIVE state is entered directly.

4.3.3. M3UA Management Procedures for Primitives

Before the establishment of an SCTP association, the ASP state at both the SGP and ASP is assumed to be in the state ASP-DOWN.

Once the SCTP association is established (see Section 4.2), assuming that the local M3UA-User is ready, the local M3UA ASP Maintenance (ASPM) function will initiate the relevant procedures, using the ASP Up/ASP Down/ASP Active/ASP Inactive messages to convey the ASP state to the SGP (see Section 4.3.4).

If the M3UA layer subsequently receives an SCTP-COMMUNICATION_DOWN or SCTP-RESTART indication primitive from the underlying SCTP layer, it will inform the Layer Management by invoking the M-SCTP_STATUS indication primitive. The state of the ASP will be moved to ASP-DOWN. At an ASP, the MTP3-User will be informed of the unavailability of any affected SS7 destinations through the use of MTP-PAUSE indication primitives.

In the case of SCTP-COMMUNICATION_DOWN, the SCTP client MAY try to re-establish the SCTP Association. This MAY be done by the M3UA layer automatically, or Layer Management MAY reestablish using the M-SCTP_ESTABLISH request primitive.

In the case of an SCTP-RESTART indication at an ASP, the ASP is now considered to be in the ASP-DOWN state by its M3UA peer. The ASP, if it is to recover, must begin any recovery with the ASP-Up procedure.

4.3.4. ASPM Procedures for Peer-to-Peer Messages

4.3.4.1. ASP Up Procedures

After an ASP has successfully established an SCTP association to an SGP, the SGP waits for the ASP to send an ASP Up message, indicating that the ASP M3UA peer is available. The ASP is always the initiator of the ASP Up message. This action MAY be initiated at the ASP by an M-ASP_UP request primitive from Layer Management or MAY be initiated automatically by an M3UA management function.

When an ASP Up message is received at an SGP and, internally, the remote ASP is in the ASP-DOWN state and is not considered locked out for local management reasons, the SGP marks the remote ASP in the state ASP-INACTIVE and informs Layer Management with an M-ASP_Up indication primitive. If the SGP is aware, via current configuration data, which Application Servers the ASP is configured to operate in, the SGP updates the ASP state to ASP-INACTIVE in each AS that it is a member.

Alternatively, the SGP may move the ASP into a pool of Inactive ASPs available for future configuration within Application Servers, determined in a subsequent Registration Request or ASP Active procedure. If the ASP Up message contains an ASP Identifier, the SGP should save the ASP Identifier for that ASP. The SGP MUST send an ASP Up Ack message in response to a received ASP Up message even if the ASP is already marked as ASP-INACTIVE at the SGP.

If for any local reason (e.g., management lockout) the SGP cannot respond with an ASP Up Ack message, the SGP responds to an ASP Up message with an Error message with the reason "Refused - Management Blocking".

At the ASP, the ASP Up Ack message received is not acknowledged. Layer Management is informed with an M-ASP_UP confirm primitive.

When the ASP sends an ASP Up message, it starts timer T(ack). If the ASP does not receive a response to an ASP Up message within T(ack), the ASP MAY restart T(ack) and resend ASP Up messages until it receives an ASP Up Ack message. T(ack) is provisionable, with a default of 2 seconds. Alternatively, retransmission of ASP Up messages MAY be put under control of Layer Management. In this method, expiry of T(ack) results in an M-ASP_UP confirm primitive carrying a negative indication.

The ASP must wait for the ASP Up Ack message before sending any other M3UA messages (e.g., ASP Active or REG REQ). If the SGP receives any other M3UA messages before an ASP Up message is received (other than ASP Down; see Section 4.3.4.2), the SGP MAY discard them.

If an ASP Up message is received and, internally, the remote ASP is in the ASP-ACTIVE state, an ASP Up Ack message is returned, as well as an Error message ("Unexpected Message"). In addition, the remote ASP state is changed to ASP-INACTIVE in all relevant Application Servers, and all registered Routing Keys are considered deregistered.

If an ASP Up message is received and, internally, the remote ASP is already in the ASP-INACTIVE state, an ASP Up Ack message is returned, and no further action is taken.

If the ASP receives an unexpected ASP Up Ack message, the ASP should consider itself in the ASP-INACTIVE state. If the ASP was not in the ASP-INACTIVE state, it SHOULD send an Error message and then initiate procedures to return itself to its previous state.

4.3.4.1.1. M3UA Version Control and ASP Up

If an ASP Up message with an unsupported version is received, the receiving end responds with an Error message, indicating the version the receiving node supports and notifies Layer Management. See Section 4.8 for more on this issue.

4.3.4.1.2. IPSP Considerations (ASP Up)

An IPSP may be considered in the ASP-INACTIVE state after an ASP Up or ASP Up Ack has been received from it. An IPSP can be considered

in the ASP-DOWN state after an ASP Down or ASP Down Ack has been received from it. The IPSP may inform Layer Management of the change in state of the remote IPSP using M-ASP_UP or M-ASP_DN indication or confirmation primitives.

Alternatively, when using the IPSP DE model, an interchange of ASP Up messages from each end MUST be performed. Four messages are needed for completion.

If for any local reason (e.g., management lockout) an IPSP cannot respond to an ASP Up message with an ASP Up Ack message, it responds to an ASP Up message with an Error message with the reason "Refused Management Blocking" and leaves the remote IPSP in the ASP-DOWN state.

4.3.4.2. ASP-Down Procedures

The ASP will send an ASP Down message to an SGP when the ASP wishes to be removed from service in all Application Servers that it is a member and no longer receive any DATA, SSNM or, ASPTM messages. This action MAY be initiated at the ASP by an M-ASP_DOWN request primitive from Layer Management or MAY be initiated automatically by an M3UA management function.

Whether the ASP is permanently removed from any AS is a function of configuration management. In the case where the ASP previously used the Registration procedures (see Section 4.4.1) to register within Application Servers but has not deregistered from all of them prior to sending the ASP Down message, the SGP MUST consider the ASP Deregistered in all Application Servers that it is still a member.

The SGP marks the ASP as ASP-DOWN, informs Layer Management with an M-ASP_Down indication primitive, and returns an ASP Down Ack message to the ASP.

The SGP MUST send an ASP Down Ack message in response to a received ASP Down message from the ASP even if the ASP is already marked as ASP-DOWN at the SGP.

At the ASP, the ASP Down Ack message received is not acknowledged. Layer Management is informed with an M-ASP_DOWN confirm primitive. If the ASP receives an ASP Down Ack without having sent an ASP Down message, the ASP should now consider itself to be in the ASP-DOWN state.

If the ASP was previously in the ASP-ACTIVE or ASP-INACTIVE state, the ASP should then initiate procedures to return itself to its previous state.

When the ASP sends an ASP Down message, it starts timer T(ack). If the ASP does not receive a response to an ASP Down message within T(ack), the ASP MAY restart T(ack) and resend ASP Down messages until it receives an ASP Down Ack message. T(ack) is provisionable, with a default of 2 seconds. Alternatively, retransmission of ASP Down messages MAY be put under control of Layer Management. In this method, expiry of T(ack) results in an M-ASP_DOWN confirm primitive, carrying a negative indication.

4.3.4.3. ASP Active Procedures

Anytime after the ASP has received an ASP Up Ack message from the SGP or IPSP, the ASP MAY send an ASP Active message to the SGP, indicating that the ASP is ready to start processing traffic. This action MAY be initiated at the ASP by an M-ASP_ACTIVE request primitive from Layer Management or MAY be initiated automatically by an M3UA management function. In the case where an ASP wishes to process the traffic for more than one Application Server across a common SCTP association, the ASP Active message(s) SHOULD contain a list of one or more Routing Contexts to indicate for which Application Servers the ASP Active message applies. It is not necessary for the ASP to include all Routing Contexts of interest in a single ASP Active message, thus requesting to become active in all Routing Contexts at the same time. Multiple ASP Active messages MAY be used to activate within the Application Servers independently, or in sets.

In the case where an ASP Active message does not contain a Routing Context parameter, the receiver must know, via configuration data, which Application Server(s) the ASP is a member.

For the Application Servers for which the ASP can be successfully activated, the SGP or IPSP responds with one or more ASP Active Ack messages, including the associated Routing Context(s) and reflecting any Traffic Mode Type value present in the related ASP Active message. The Routing Context parameter MUST be included in the ASP Active Ack message(s) if the received ASP Active message contained any Routing Contexts. Depending on any Traffic Mode Type request in the ASP Active message, or local configuration data if there is no request, the SGP moves the ASP to the correct ASP traffic state within the associated Application Server(s). Layer Management is informed with an M-ASP_Active indication. If the SGP or IPSP receives any Data messages before an ASP Active message is received, the SGP or IPSP MAY discard them. By sending an ASP Active Ack message, the SGP or IPSP is now ready to receive and send traffic for the related Routing Context(s). The ASP SHOULD NOT send Data or SSNM messages for the related Routing Context(s) before receiving an ASP Active Ack message, or it will risk message loss.

Multiple ASP Active Ack messages MAY be used in response to an ASP Active message containing multiple Routing Contexts, allowing the SGP or IPSP to independently acknowledge the ASP Active message for different (sets of) Routing Contexts.

The ASP Active message will be responded to in the following way as a function of the presence/need of the RC parameter:

- If the RC parameter is included in the ASP Active message and the corresponding RK has been previously defined (by either static configuration or dynamic registration), the peer node MUST respond with an ASP Active Ack message. If for any local reason (e.g., management lockout) the SGP responds to an ASP Active message with an Error message with reason "Refused Management Blocking".
- If the RC parameter is included in the ASP Active message and a corresponding RK has not been previously defined (by either static configuration or dynamic registration), the peer MUST respond with an ERROR message with the Error Code "No configured AS for ASP".
- If (1) the RC parameter is not included in the ASP Active message, (2) there are RKs defined (by either static configuration or dynamic registration) and (3) RC is not mandatory, the peer node SHOULD respond with an ASP Active Ack message and activate all the RKs it has defined for that specific ASP.
- If (!) the RC parameter is not included in the ASP Active message, (2) there are RKs defined (by either static configuration or dynamic registration), (3) and RC is mandatory, the peer node MUST respond with an ERROR message with the Error Code "Missing Parameter".
- If (1) the RC parameter is not included in the ASP Active message, (2) there are RKs defined (by either static configuration or dynamic registration) and (3) RC is not mandatory, the peer node MUST respond with an ASP Active Ack message if it is ready to handle traffic; otherwise, it will send an ERROR message with the Error Code "No Configured AS for ASP" (meaning that it is not ready to become active).
- If the RC parameter is not included in the ASP Active message and there are no RKs defined, the peer node SHOULD respond with an ERROR message with the Error Code "Invalid Routing Context".

Independently of the RC, the SGP MUST send an ASP Active Ack message in response to a received ASP Active message from the ASP, if the ASP is already marked in the APS-ACTIVE state.

At the ASP, the ASP Active Ack message received is not acknowledged. Layer Management is informed with an M-ASP_ACTIVE confirm primitive. It is possible for the ASP to receive Data messages before the ASP Active Ack message as the ASP Active Ack and Data messages from an SG or IPSP may be sent on different SCTP streams. Message loss is possible, as the ASP does not consider itself in the ASP-ACTIVE state until receipt of the ASP Active Ack message.

When the ASP sends an ASP Active message, it starts the timer T(ack). If the ASP does not receive a response to an ASP Active message within T(ack), the ASP MAY restart T(ack) and resend ASP Active messages until it receives an ASP Active Ack message. T(ack) is provisionable, with a default of 2 seconds. Alternatively, retransmission of ASP Active messages MAY be put under control of Layer Management. In this method, expiry of T(ack) results in an M-ASP_ACTIVE confirm primitive carrying a negative indication.

There are three modes of Application Server traffic handling in the SGP M3UA layer: Override, Loadshare and Broadcast. When included, the Traffic Mode Type parameter in the ASP Active message indicates the traffic handling mode to be used in a particular Application Server. If the SGP determines that the mode indicated in an ASP Active message is unsupported or incompatible with the mode currently configured for the AS, the SGP responds with an Error message ("Unsupported / Invalid Traffic Handling Mode"). If the traffic handling mode of the Application Server is not already known via configuration data, then the traffic handling mode indicated in the first ASP Active message causing the transition of the Application Server state to AS-ACTIVE MAY be used to set the mode.

In the case of an Override mode AS, receipt of an ASP Active message at an SGP causes the (re)direction of all traffic for the AS to the ASP that sent the ASP Active message. Any previously active ASP in the AS is now considered to be in the state ASP-INACTIVE and SHOULD no longer receive traffic from the SGP within the AS. The SGP or IPSP then MUST send a Notify message ("Alternate ASP_Active") to the previously active ASP in the AS and SHOULD stop traffic to/from that ASP. The ASP receiving this Notify MUST consider itself now in the ASP-INACTIVE state, if it is not already aware of this via inter-ASP communication with the Overriding ASP.

In the case of a Loadshare mode AS, receipt of an ASP Active message at an SGP or IPSP causes direction of traffic to the ASP sending the ASP Active message, in addition to all the other ASPs that are currently active in the AS. The algorithm at the SGP for loadsharing traffic within an AS to all the active ASPs is implementation dependent. The algorithm could, for example, be round-robin or based on information in the Data message (e.g., the SLS, SCCP SSN, or ISUP

CIC value). An SGP or IPSP, upon receipt of an ASP Active message for the first ASP in a Loadshare AS, MAY choose not to direct traffic to a newly active ASP until it determines that there are sufficient resources to handle the expected load (e.g., until there are "n" ASPs in state ASP-ACTIVE in the AS). In this case, the SGP or IPSP SHOULD withhold the Notify (AS-ACTIVE) until there are sufficient resources.

For the n+k redundancy case, ASPs that are in that AS should coordinate among themselves the number of active ASPs in the AS and should start sending traffic only after n ASPs are active. All ASPs within a loadsharing mode AS must be able to process any Data message received for the AS, to accommodate any potential failover or rebalancing of the offered load.

In the case of a Broadcast mode AS, receipt of an ASP Active message at an SGP or IPSP causes direction of traffic to the ASP sending the ASP Active message, in addition to all the other ASPs that are currently active in the AS. The algorithm at the SGP for broadcasting traffic within an AS to all the active ASPs is a simple broadcast algorithm, where every message is sent to each of the active ASPs.

At startup or restart phases, an SGP or IPSP, upon receipt of an ASP Active message for the first ASP in a Loadshare AS, SHOULD NOT direct traffic to a newly active ASP until it determines that there are sufficient resources to handle the expected load (e.g., until there are "n" ASPs in state ASP-ACTIVE in the AS). In this case, the SGP or IPSP SHOULD withhold the Notify (AS-ACTIVE) until there are sufficient resources.

An SGP or IPSP, upon receipt of an ASP Active message for the first ASP in a Broadcast AS, MAY choose not to direct traffic to a newly active ASP until it determines that there are sufficient resources to handle the expected load (e.g., until there are "n" ASPs in state ASP-ACTIVE in the AS). In this case, the SGP or IPSP SHOULD withhold the Notify (AS-ACTIVE) until there are sufficient resources.

For the n+k redundancy case, ASPs that are in that AS should coordinate among themselves the number of active ASPs in the AS and should start sending traffic only after n ASPs are active.

Whenever an ASP in a Broadcast mode AS becomes ASP-ACTIVE, the SGP MUST tag the first DATA message broadcast in each traffic flow with a unique Correlation Id parameter. The purpose of this Id is to permit the newly active ASP to synchronize its processing of traffic in each traffic flow with the other ASPs in the broadcast group.

4.3.4.3.1. IPSP Considerations (ASP Active)

Either of the IPSPs can initiate communication. When an IPSP receives an ASP Active, it should mark the peer as ASP-ACTIVE and return an ASP Active Ack message. An ASP receiving an ASP Active Ack message may mark the peer as ASP-Active, if it is not already in the ASP-ACTIVE state.

Alternatively, when using the IPSP DE model, an interchange of ASP Active messages from each end MUST be performed. Four messages are needed for completion.

4.3.4.4. ASP Inactive Procedures

When an ASP wishes to withdraw from receiving traffic within an AS or the ASP wants to initiate the process of deactivation, the ASP sends an ASP Inactive message to the SGP or IPSP.

An ASP Inactive message MUST always be responded to by the peer (although other messages may be sent in the middle) in the following way:

- If the received ASP Inactive message contains an RC parameter and the corresponding RK is defined (by either static configuration or dynamic registration), the SGP/IPSP MUST respond with an ASP Inactive Ack message.
- If the received ASP Inactive message contains an RC parameter that is not defined (by either static configuration or dynamic registration), the SGP/IPSP MUST respond with an ERROR message with the Error Code "Invalid Routing Context".
- If the received ASP Inactive message does not contain an RC parameter and the RK is defined (by either static configuration or dynamic registration), the SGP/IPSP must turn the ASP/IPSP to ASP-INACTIVE state in all the ASes it serves and MUST respond with an ASP Inactive Ack message.
- If the received ASP Inactive message does not contain an RC parameter and the RK is not defined (by either static configuration or dynamic registration), the SGP/IPSP MUST respond with an ERROR message with the Error Code "No configured AS for ASP".

The action of sending the ASP Inactive message MAY be initiated at the ASP by an M-ASP_INACTIVE request primitive from Layer Management or MAY be initiated automatically by an M3UA management function. In the case where an ASP is processing the traffic for more than one

Application Server across a common SCTP association, the ASP Inactive message contains one or more Routing Contexts to indicate for which Application Servers the ASP Inactive message applies.

In the case where an ASP Inactive message does not contain a Routing Context parameter, the receiver must know, via configuration data, which Application Servers the ASP is a member of and then move the ASP to the ASP-INACTIVE state in all Application Servers.

In the case of an Override mode AS, where another ASP has already taken over the traffic within the AS with an ASP Active ("Override") message, the ASP that sends the ASP Inactive message is already considered to be in ASP-INACTIVE state by the SGP. An ASP Inactive Ack message is sent to the ASP, after ensuring that all traffic is stopped to the ASP.

In the case of a Loadshare mode AS, the SGP moves the ASP to the ASP-INACTIVE state, and the AS traffic is reallocated across the remaining ASPs in the state ASP-ACTIVE, as per the loadsharing algorithm currently used within the AS. A Notify message ("Insufficient ASP resources active in AS") MAY be sent to all inactive ASPs, if required. An ASP Inactive Ack message is sent to the ASP after all traffic is halted, and Layer Management is informed with an M-ASP_INACTIVE indication primitive.

In the case of a Broadcast mode AS, the SGP moves the ASP to the ASP-INACTIVE state, and the AS traffic is broadcast only to the remaining ASPs in the state ASP-ACTIVE. A Notify message ("Insufficient ASP resources active in AS") MAY be sent to all inactive ASPs, if required. An ASP Inactive Ack message is sent to the ASP after all traffic is halted, and Layer Management is informed with an M-ASP_INACTIVE indication primitive.

Multiple ASP Inactive Ack messages MAY be used in response to an ASP Inactive message containing multiple Routing Contexts, allowing the SGP or IPSP to independently acknowledge for different (sets of) Routing Contexts. The SGP or IPSP sends an Error message ("Invalid Routing Context") message for each invalid or unconfigured Routing Context value in a received ASP Inactive message.

The SGP MUST send an ASP Inactive Ack message in response to a received ASP Inactive message from the ASP; the ASP is already marked as ASP-INACTIVE at the SGP.

At the ASP, the ASP Inactive Ack message received is not acknowledged. Layer Management is informed with an M-ASP_INACTIVE confirm primitive. If the ASP receives an ASP Inactive Ack without having sent an ASP Inactive message, the ASP should now consider

itself to be in the ASP-INACTIVE state. If the ASP was previously in the ASP-ACTIVE state, the ASP should then initiate procedures to return itself to its previous state.

When the ASP sends an ASP Inactive message, it starts the timer T(ack). If the ASP does not receive a response to an ASP Inactive message within T(ack), the ASP MAY restart T(ack) and resend ASP Inactive messages until it receives an ASP Inactive Ack message. T(ack) is provisionable, with a default of 2 seconds. Alternatively, retransmission of ASP Inactive messages MAY be put under control of Layer Management. In this method, expiry of T(ack) results in an M-ASP_Inactive confirm primitive carrying a negative indication.

If no other ASPs in the Application Server are in the state ASP-ACTIVE, the SGP MUST send a Notify message ("AS-Pending") to all ASPs in the AS that are in the state ASP-INACTIVE. The SGP SHOULD start buffering the incoming messages for T(r) seconds, after which messages MAY be discarded. T(r) is configurable by the network operator. If the SGP receives an ASP Active message from an ASP in the AS before expiry of T(r), the buffered traffic is directed to that ASP, and the timer is cancelled. If T(r) expires, the AS is moved to the AS-INACTIVE state.

4.3.4.4.1. IPSP Considerations (ASP Inactive)

An IPSP may be considered in the ASP-INACTIVE state by a remote IPSP after an ASP Inactive or ASP Inactive Ack message has been received from it.

Alternatively, when using IPSP DE model, an interchange of ASP Inactive messages from each end MUST be performed. Four messages are needed for completion.

4.3.4.4.5. Notify Procedures

A Notify message reflecting a change in the AS state MUST be sent to all ASPs in the AS, except those in the ASP-DOWN state, with appropriate Status Information and any ASP Identifier of the failed ASP. At the ASP, Layer Management is informed with an M-NOTIFY indication primitive. The Notify message must be sent whether the AS state change was a result of an ASP failure or receipt of an ASP State management (ASPSM) / ASP Traffic Management (ASPTM) message. In the second case, the Notify message MUST be sent after any related acknowledgement messages (e.g., ASP Up Ack, ASP Down Ack, ASP Active Ack, or ASP Inactive Ack).

When an ASP moves from ASP-DOWN to ASP-INACTIVE within a particular AS, a Notify message SHOULD be sent, by the ASP-UP receptor, after

sending the ASP-UP-ACK, in order to inform the ASP of the current AS state.

In the case where a Notify message ("AS-PENDING") message is sent by an SGP that now has no ASPs active to service the traffic, or where a Notify ("Insufficient ASP resources active in AS") message is sent in the Loadshare or Broadcast mode, the Notify message does not explicitly compel the ASP(s) receiving the message to become active. The ASPs remain in control of what (and when) traffic action is taken.

In the case where a Notify message does not contain a Routing Context parameter, the receiver must know, via configuration data, of which Application Servers the ASP is a member and take the appropriate action in each AS.

4.3.4.5.1. IPSP Considerations (NTFY)

Notify works in the same manner as in the SG-AS case. One of the IPSPs can send this message to any remote IPSP that is not in the ASP-DOWN state.

4.3.4.6. Heartbeat Procedures

The optional Heartbeat procedures MAY be used when operating over transport layers that do not have their own heartbeat mechanism for detecting loss of the transport association (i.e., other than SCTP). Either M3UA peer may optionally send Heartbeat messages periodically, subject to a provisionable timer, T(beat). Upon receiving a Heartbeat message, the M3UA peer MUST respond with a Heartbeat Ack message.

If no Heartbeat Ack message (or any other M3UA message) is received from the M3UA peer within $2 * T(\text{beat})$, the remote M3UA peer is considered unavailable. Transmission of Heartbeat messages is stopped, and the signalling process SHOULD attempt to re-establish communication if it is configured as the client for the disconnected M3UA peer.

The Heartbeat message may optionally contain an opaque Heartbeat Data parameter that MUST be echoed back unchanged in the related Heartbeat Ack message. The sender, upon examining the contents of the returned Heartbeat Ack message, MAY choose to consider the remote M3UA peer as unavailable. The contents/format of the Heartbeat Data parameter is implementation-dependent and only of local interest to the original sender. The contents may be used, for example, to support a Heartbeat sequence algorithm (to detect missing Heartbeats), and/or a timestamp mechanism (to evaluate delays).

Note: Heartbeat-related events are not shown in Figure 3 "ASP state transition diagram".

4.4. Routing Key Management Procedures [Optional]

4.4.1. Registration

An ASP MAY dynamically register with an SGP as an ASP within an Application Server using the REG REQ message. A Routing Key parameter in the REG REQ message specifies the parameters associated with the Routing Key.

The SGP examines the contents of the received Routing Key parameter and compares it with the currently provisioned Routing Keys. If the received Routing Key matches an existing SGP Routing Key entry and the ASP is not currently included in the list of ASPs for the related Application Server, the SGP MAY authorize the ASP to be added to the AS. Or, if the Routing Key does not currently exist and the received Routing Key data is valid and unique, an SGP supporting dynamic configuration MAY authorize the creation of a new Routing Key and related Application Server and add the ASP to the new AS. In either case, the SGP returns a Registration Response message to the ASP, containing the same Local-RK-Identifier as provided in the initial request, and a Registration Result "Successfully Registered". A unique Routing Context value assigned to the SGP Routing Key is included. The method of Routing Context value assignment at the SGP is implementation dependent but must be guaranteed to be unique for each Application Server or Routing Key supported by the SGP.

If the SGP does not support the registration procedure, the SGP returns an Error message to the ASP, with an error code of "Unsupported Message Class".

If the SGP determines that the received Routing Key data is invalid, or contains invalid parameter values, the SGP returns a Registration Response message to the ASP, containing a Registration Result "Error Invalid Routing Key", "Error - Invalid DPC", or "Error - Invalid Network Appearance", as appropriate.

If the SGP determines that the requested RK partially, but not exactly, matches an existing RK, and that an incoming signalling message received at an SGP could possibly match both the requested and the existing RK, the SGP returns a Registration Response message to the ASP, with a Registration Status of "Error - Cannot Support Unique Routing". An incoming signalling message received at an SGP should not match against more than one Routing Key.

If the SGP determines that the received RK was already registered, fully and exactly, either statically or dynamically, by the sending ASP, the SGP returns a Registration Response message to the ASP, containing a Registration Result "Error - Routing Key Already Registered". This error applies whether the sending ASP/IPSP is in ASP-ACTIVE or ASP-INACTIVE for the corresponding AS. For this error code, the RC field in the Registration Response message MUST be populated with the actual value of RC in SGP corresponding to the specified RK in the Registration Request message.

An ASP MAY request modification of an existing Routing Key by including a Routing Context parameter in a Registration Request message. Upon receipt of a Registration Request message containing a Routing Context, if the SGP determines that the Routing Context applies to an existing Routing Key, the SGP MAY adjust the existing Routing Key to match the new information provided in the Routing Key parameter. A Registration Response "ERR Routing Key Change Refused" is returned if the SGP does not support this re-registration procedure or RC does not exist. Otherwise, a Registration Response "Successfully Registered" is returned.

If the SGP does not authorize an otherwise valid registration request, the SGP returns a REG RSP message to the ASP containing the Registration Result "Error - Permission Denied".

If an SGP determines that a received Routing Key does not currently exist, and that the SGP does not support dynamic configuration, the SGP returns a Registration Response message to the ASP, containing a Registration Result "Error - Routing Key not Currently Provisioned".

If an SGP determines that a received Routing Key does not currently exist and that the SGP supports dynamic configuration but does not have the capacity to add new Routing Key and Application Server entries, the SGP returns a Registration Response message to the ASP, containing a Registration Result "Error - Insufficient Resources".

If an SGP determines that a received Routing Key does not currently exist, and the SGP supports dynamic configuration but requires that the Routing Key first be manually provisioned at the SGP, the SGP returns a Registration Response message to the ASP, containing a Registration Result "Error - Routing Key not Currently Provisioned".

If an SGP determines that one or more of the Routing Key parameters are not supported for the purpose of creating new Routing Key entries, the SGP returns a Registration Response message to the ASP, containing a Registration Result "Error - Unsupported RK parameter field".

A Registration Response "Error - Unsupported Traffic Handling Mode" is returned if the Routing Key in the REG REQ contains an Traffic Handling Mode that is inconsistent with the presently configured mode for the matching Application Server.

An ASP MAY register multiple Routing Keys at once by including a number of Routing Key parameters in a single REG REQ message. The SGP MAY respond to each registration request in a single REG RSP message, indicating the success or failure result for each Routing Key in a separate Registration Result parameter. Alternatively the SGP MAY respond with multiple REG RSP messages, each with one or more Registration Result parameters. The ASP uses the Local-RK-Identifier parameter to correlate the requests with the responses.

Upon successful registration of an ASP in an AS, the SGP can now send related SS7 Signalling Network Management messaging, if this did not previously start upon the ASP transitioning to state ASP-INACTIVE

4.4.2. Deregistration

An ASP MAY dynamically deregister with an SGP as an ASP within an Application Server using the DEREG REQ message. A Routing Context parameter in the DEREG REQ message specifies which Routing Keys to deregister. An ASP SHOULD move to the ASP-INACTIVE state for an Application Server before attempting to deregister the Routing Key (i.e., deregister after receiving an ASP Inactive Ack). Also, an ASP SHOULD deregister from all Application Servers of which it is a member before attempting to move to the ASP-Down state.

The SGP examines the contents of the received Routing Context parameter and validates that the ASP is currently registered in the Application Server(s) related to the included Routing Context(s). If validated, the ASP is deregistered as an ASP in the related Application Server.

The deregistration procedure does not necessarily imply the deletion of Routing Key and Application Server configuration data at the SG.

Other ASPs may continue to be associated with the Application Server, in which case the Routing Key data SHOULD NOT be deleted. If a Deregistration results in no more ASPs in an Application Server, an SG MAY delete the Routing Key data.

The SGP acknowledges the deregistration request by returning a DEREG RSP message to the requesting ASP. The result of the deregistration is found in the Deregistration Result parameter, indicating success or failure with cause.

An ASP MAY deregister multiple Routing Contexts at once by including a number of Routing Contexts in a single DEREG REQ message. The SGP MAY respond to each deregistration request in a single DEREG RSP message, indicating the success or failure result for each Routing Context in a separate Deregistration Result parameter.

4.4.3. IPSP Considerations (REG/DEREG)

The Registration/Deregistration procedures work in the IPSP cases in the same way as in AS-SG cases. An IPSP may register an RK in the remote IPSP. An IPSP is responsible for deregistering the RKs that it has registered.

4.5. Procedures to Support the Availability or Congestion Status of SS7 Destination

4.5.1. At an SGP

On receiving an MTP-PAUSE, MTP-RESUME or MTP-STATUS indication primitive from the nodal interworking function at an SGP, the SGP M3UA layer will send a corresponding SS7 Signalling Network Management (SSNM) DUNA, DAVA, SCON, or DUPU message (see Section 3.4) to the M3UA peers at concerned ASPs. The M3UA layer must fill in various fields of the SSNM messages consistently with the information received in the primitives.

The SGP M3UA layer determines the set of concerned ASPs to be informed based on the specific SS7 network for which the primitive indication is relevant. In this way, all ASPs configured to send/receive traffic within a particular Network Appearance are informed. If the SGP operates within a single SS7 Network Appearance, then all ASPs are informed.

For the particular case that an ASP becomes active for an AS and destinations normally accessible to the AS are inaccessible, restricted, or congested, the SG MAY send DUNA, DRST, or SCON messages for the inaccessible, restricted, or congested destinations to the ASP newly active for the AS to prevent the ASP from sending traffic for destinations that it might not otherwise know that are inaccessible, restricted, or congested. For the newly activating ASP from which the SGP has received an ASP Active message, these DUNA, DRST, and SCON messages MAY be sent before sending the ASP Active Ack that completes the activation procedure.

DUNA, DAVA, SCON, and DRST messages may be sent sequentially and processed at the receiver in the order sent.

Sequencing is not required for the DUPU or DAUD messages, which MAY be sent unsequenced.

4.5.2. At an ASP

4.5.2.1. Single SG Configurations

At an ASP, upon receiving an SS7 Signalling Network Management (SSNM) message from the remote M3UA Peer, the M3UA layer invokes the appropriate primitive indications to the resident M3UA-Users. Local management is informed.

In the case where a local event has caused the unavailability or congestion status of SS7 destinations, the M3UA layer at the ASP SHOULD pass up appropriate indications in the primitives to the M3UA User, as though equivalent SSNM messages were received. For example, the loss of an SCTP association to an SGP may cause the unavailability of a set of SS7 destinations. MTP-PAUSE indication primitives to the M3UA User are appropriate.

4.5.2.2. Multiple SG Configurations

At an ASP, upon receiving a Signalling Network Management message from the remote M3UA Peer, the M3UA layer updates the status of the affected route(s) via the originating SG and determines whether or not the overall availability or congestion status of the affected destination(s) has changed. If so, the M3UA layer invokes the appropriate primitive indications to the resident M3UA-Users. Local management is informed.

Implementation Note: To accomplish this, the M3UA layer at an ASP maintains the status of routes via the SG, much like an MTP3 layer maintains route-set status.

4.5.3. ASP Auditing

An ASP may optionally initiate an audit procedure to enquire of an SGP the availability and (if the national congestion method with multiple congestion levels and message priorities is used) congestion status of an SS7 destination or set of destinations. A Destination Audit (DAUD) message is sent from the ASP to the SGP, requesting the current availability and congestion status of one or more SS7 Destination Point Codes.

The DAUD message MAY be sent unsequenced. The DAUD MAY be sent by the ASP in the following cases:

- Periodic. A Timer originally set upon receipt of a DUNA, SCON, or DRST message has expired without a subsequent DAVA, DUNA, SCON, or DRST message updating the availability/congestion status of the affected Destination Point Codes. The Timer is reset upon issuing a DAUD. In this case, the DAUD is sent to the SGP that originally sent the SSNM message.
- Isolation. The ASP is newly ASP-ACTIVE or has been isolated from an SGP for an extended period. The ASP MAY request the availability/congestion status of one or more SS7 destinations to which it expects to communicate.

Implementation Note: In the first of the cases above, the auditing procedure must not be invoked for the case of a received SCON message containing a congestion level value of "no congestion" or "undefined" (i.e., congestion Level = "0").

The SGP SHOULD respond to a DAUD message with the MTP3 availability/congestion status of the routeset associated with each Destination Point Codes in the DAUD message. The status of each SS7 destination requested is indicated in a DUNA message (if unavailable), a DAVA message (if available), or a DRST (if restricted and the SGP supports this feature in national networks). For national networks, the SGP SHOULD additionally respond with a SCON message (if the destination is congested) before the DAVA or DRST.

Where the SGP does not maintain the congestion status of the SS7 destination, the response to a DAUD message should always only be a DAVA, DRST, or DUNA message, as appropriate.

Any DUNA or DAVA message in response to a DAUD message MAY contain a list of Affected Point Codes.

An SG MAY refuse to provide the availability or congestion status of a destination if, for example, the ASP is not authorized to know the status of the destination. The SG MAY respond with an Error Message (Error Code = "Destination Status Unknown").

An SG SHOULD respond with a DUNA message when DAUD was received with an unknown Signalling Point Code.

4.6. MTP3 Restart

In the case where the MTP3 in the SG undergoes an MTP restart, event communication SHOULD be handled as follows:

When the SG discovers SS7 network isolation, the SGPs send an indication to all concerned available ASPs (i.e., ASPs in the ASP-ACTIVE state), using DUNA messages for the concerned destinations.

When the SG has completed the MTP Restart procedure, the M3UA layers at the SGPs inform all concerned ASPs in the ASP-ACTIVE state of any available/restricted SS7 destinations, using the DAVA/DRST messages. No message is necessary for those destinations still unavailable after the restart procedure.

When the M3UA layer at an ASP receives a DUNA message indicating SS7 destination unavailability at an SG, MTP Users will receive an MTP-PAUSE indication and will stop any affected traffic to this destination. When the M3UA receives a DAVA/DRST message, MTP Users will receive an MTP-RESUME indication and can resume traffic to the newly available SS7 destination, provided that the ASP is in the ASP-ACTIVE state towards this SGP.

The ASP MAY choose to audit the availability of unavailable destinations by sending DAUD messages. This would be the case when, for example, an AS becomes active at an ASP and does not have current destination statuses. If MTP restart is in progress at the SG, the SGP returns a DUNA message for that destination, even if it received an indication that the destination became available or restricted.

When an ASP becomes active for an AS and the SG is experiencing SS7 network isolation or is performing the MTP Restart procedure for the AS, the SG MAY send a DUNA message for the concerned destinations to the newly active ASP to prevent the ASP from sending traffic. These messages can be sent after receiving the ASP Active, and before sending the ASP Active Ack, to ensure that traffic is not initiated by the ASP to these destinations before the SSNM are received. In addition to DUNA messages, SCON, DRST, and DAVA can also be sent.

In the IPSP case, MTP restart could be considered if the IPSP also has connection to an SS7 network. In that case, the same behavior as described above for the SGP would apply to the restarting IPSP. This would also be the case if the IPSPs were perceived as exchanging MTP Peer PDUs, instead of MTP primitives between MTP User and MTP Provider. In other words, M3UA does not provide the equivalent to Traffic Restart Allowed messages indicating the end of the restart procedure between peer IPSPs that would also be connected to an SS7 network.

4.7. NIF Not Available

Implementation Note: Although the NIF is decided to be an implementation dependent function, here are some guidelines that may be useful to follow:

- If an SGP is isolated entirely from the NIF, the SGP should send ASP Down Ack to all its connected ASPs. Upon receiving an ASP Up message while isolated from the NIF, the SGP should respond with an Error ("Refused - Management Blocking").
- If an SGP suffers a partial failure (where an SGP can continue to service one or more active AS but due to a partial failure it is unable to service one or more other active AS), the SGP should send ASP Inactive Ack to all its connected ASPs for the affected AS. Upon receiving an ASP Active message for an affected AS while still partially isolated from the NIF, the SGP should respond with an Error ("Refused - Management Blocking").
- If SG is isolated from NIF, it means that each SGP within an SG should follow the procedure mentioned above.

4.8. M3UA Version Control

If a message with an unsupported version is received, the receiving end responds with an Error message indicating the version the receiving node supports and notifies Layer Management.

This is useful when protocol version upgrades are being performed in a network. A node upgraded to a newer version should support the older versions used on other nodes it is communicating with. Because ASPs initiate the ASP Up procedure, it is likely that the message having an unsupported version is an ASP Up message and therefore that the Error message would normally come from the SGP.

4.9. M3UA Termination

Whenever a M3UA node wants to stop the communication with the peer node, it MAY use one of the following procedures:

- a) Send the sequence of ASP-INACTIVE, Dereg (optionally whenever dynamic registration is used), and ASP-DOWN messages and perform the SCTP Shutdown procedure after that.
- b) Just do the SCTP Shutdown procedure.

5. Examples of M3UA Procedures

5.1. Establishment of Association and Traffic between SGPs and ASPs

These scenarios show examples of M3UA message flows for the establishment of traffic between an SGP and an ASP or between two IPSPs. In all cases it is assumed that the SCTP association is already set up.

5.1.1. Single ASP in an Application Server ("1+0" sparing), No Registration

These scenarios show examples of M3UA message flows for the establishment of traffic between an SGP and an ASP where only one ASP is configured within an AS (no backup).

5.1.1.1. Single ASP in an Application Server ("1+0" Sparing), No Registration

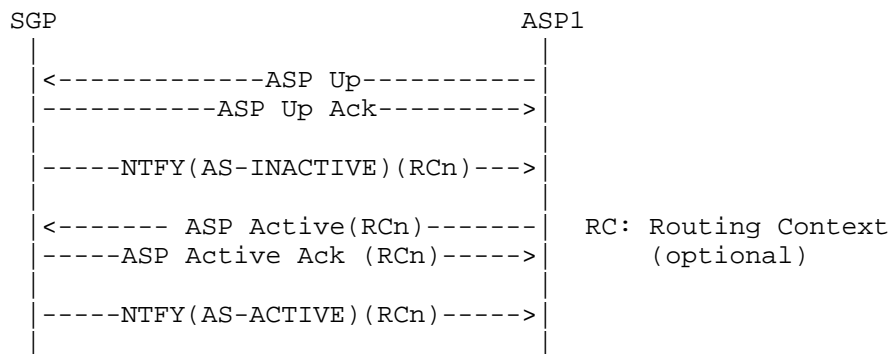

Note: If the ASP Active message contains an optional Routing Context parameter, the ASP Active message only applies for the specified RC value(s). For an unknown RC value, the SGP responds with an Error message.

5.1.1.2. Single ASP in Application Server ("1+0" Sparing), Dynamic Registration

This scenario is the same as for 5.1.1.1 but with the optional exchange of registration information. In this case, the Registration is accepted by the SGP.

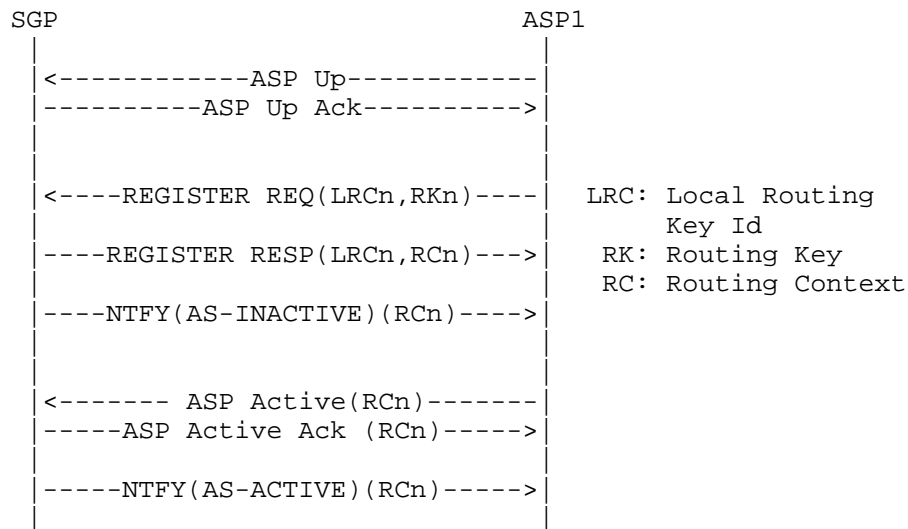

Note: In the case of an unsuccessful registration attempt (e.g., invalid RKn), the Register Response message will contain an unsuccessful indication, and the ASP will not subsequently send an ASP Active message.

5.1.1.3. Single ASP in Multiple Application Servers (Each with "1+0" Sparing), Dynamic Registration (Case 1 - Multiple Registration Requests)

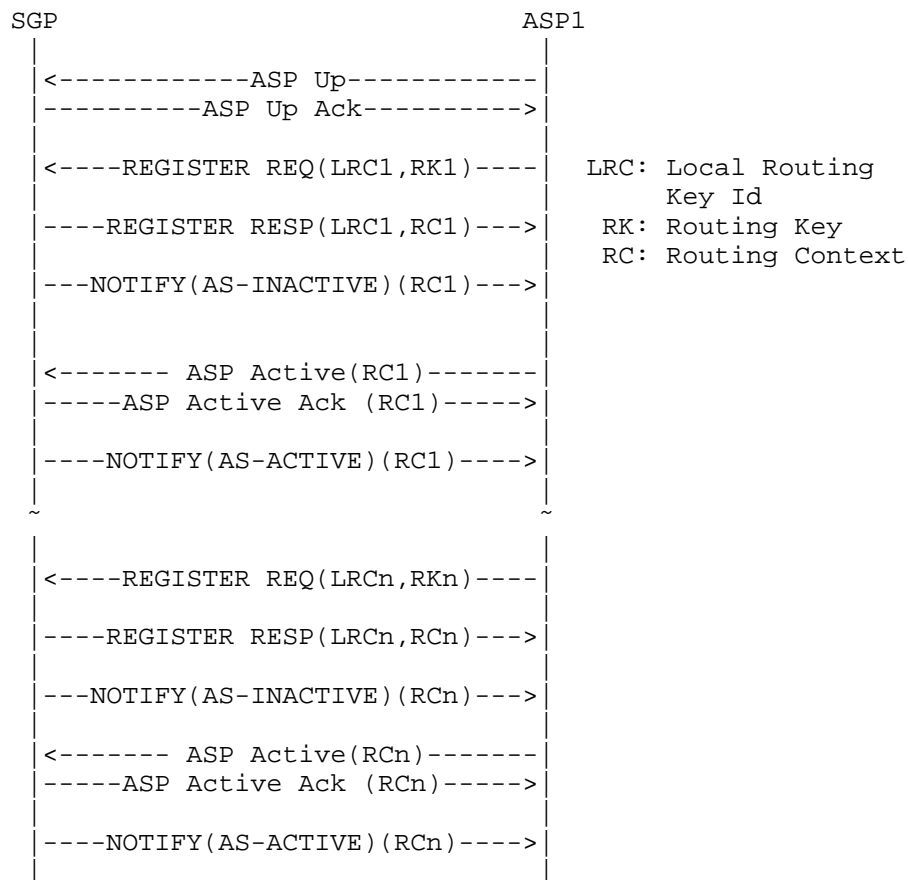

Note: In the case of an unsuccessful registration attempt (e.g., invalid RKn), the Register Response message will contain an unsuccessful indication, and the ASP will not subsequently send an ASP Active message. Each LRC/RK pair registration is considered independently.

It is not necessary to follow a Registration Request/Response message pair with an ASP Active message before sending the next Registration Request. The ASP Active message can be sent at any time after the related successful registration.

5.1.1.4. Single ASP in Multiple Application Servers (each with "1+0" sparing), Dynamic Registration (Case 2 - Single Registration Request)

```

SGP                                     ASP1
|                                       |
|<-----ASP Up----->              |
|-----ASP Up Ack----->           |
|                                       |
|<---REGISTER REQ({LRC1,RK1},        |
|                  ...'              |
|                  {LRCn,RKn}),--    |
|                                       |
|---REGISTER RESP({LRC1,RC1},-->    |
|                  ...'              |
|                  (LRCn,RCn})      |
|                                       |
|--NTFY(AS-INACTIVE)(RC1..RCn)->    |
|                                       |
|<----- ASP Active(RC1)----->    |
|-----ASP Active Ack (RC1)-----> |
|                                       |
|----NOTIFY(AS-ACTIVE)(RC1)---->    |
|                                       |
|:                                     |:
|:                                     |:
|                                       |
|<----- ASP Active(RCn)----->    |
|-----ASP Active Ack (RCn)-----> |
|                                       |
|----NOTIFY(AS-ACTIVE)(RCn)---->    |
|                                       |

```

Note: In the case of an unsuccessful registration attempt (e.g., Invalid RKn), the Register Response message will contain an unsuccessful indication, and the ASP will not subsequently send an ASP Active message. Each LRC/RK pair registration is considered independently.

The ASP Active message can be sent at any time after the related successful registration and may have more than one RC.

5.1.2. Two ASPs in Application Server ("1+1" Sparing)

This scenario shows example M3UA message flows for the establishment of traffic between an SGP and two ASPs in the same Application Server, where ASP1 is configured to be in the ASP-ACTIVE state and ASP2 is to be a "backup" in the event of communication failure or the withdrawal from service of ASP1. ASP2 may act as a hot, warm, or cold backup, depending on the extent to which ASP1 and ASP2 share call/transaction state or can communicate call state under failure/withdrawal events. The example message flow is the same whether the ASP Active messages indicate "Override", "Loadshare", or "Broadcast" mode, although typically this example would use an Override mode.

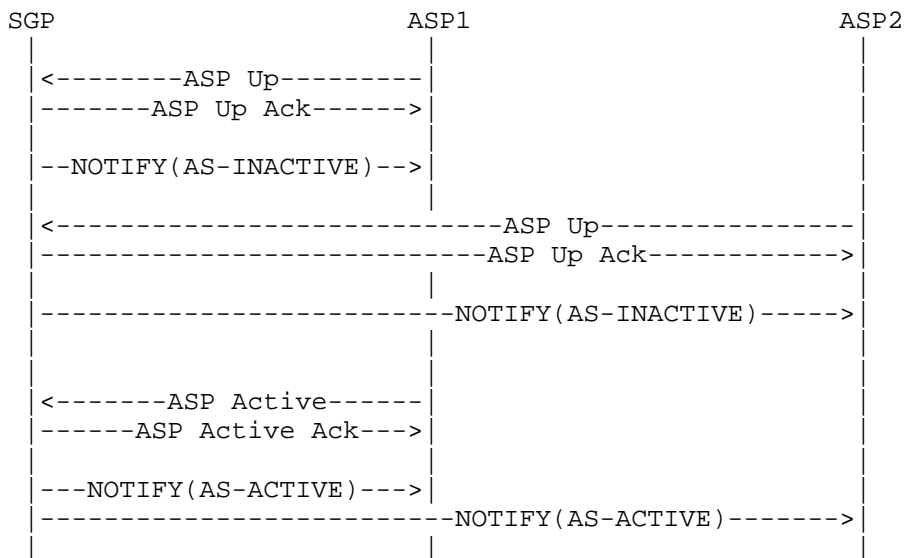

5.1.3. Two ASPs in an Application Server ("1+1" Sparing, Loadsharing Case)

This scenario shows a case similar to Section 5.1.2, but where the two ASPs are brought to the state ASP-ACTIVE and subsequently loadshare the traffic. In this case, one ASP is sufficient to handle the total traffic load.

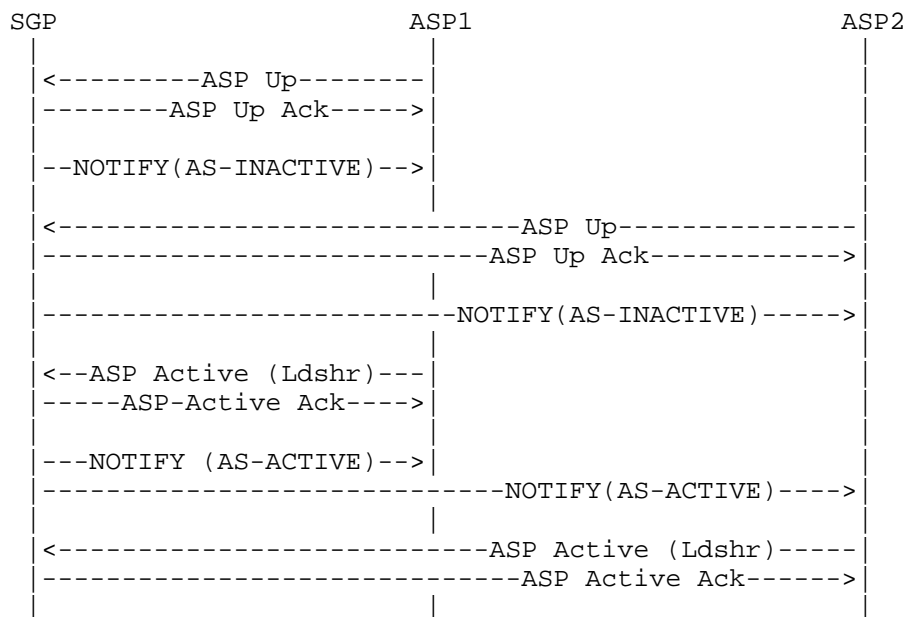

5.1.4. Three ASPs in an Application Server ("n+k" Sparing, Loadsharing Case)

This scenario shows example M3UA message flows for the establishment of traffic between an SGP and three ASPs in the same Application Server, where two of the ASPs are brought to the state ASP-ACTIVE and subsequently share the load. In this case, a minimum of two ASPs are required to handle the total traffic load (2+1 sparing).

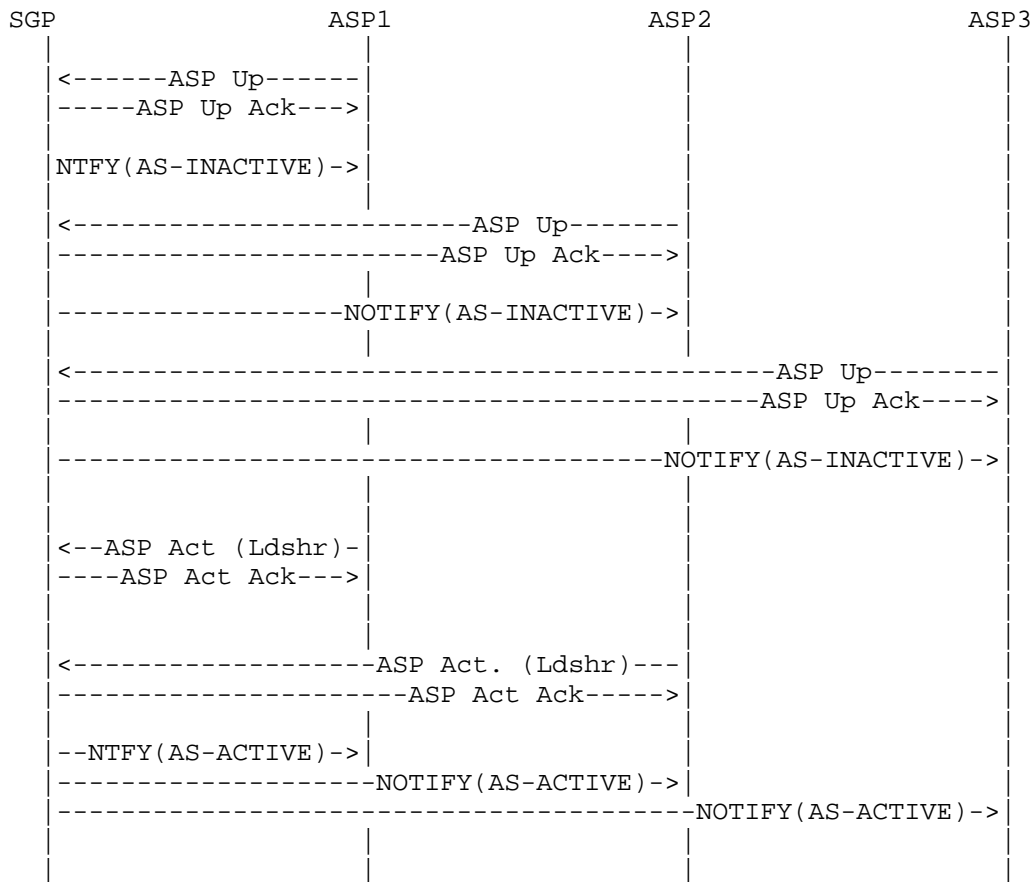

5.2. ASP Traffic Failover Examples

5.2.1. 1+1 Sparing, Withdrawal of ASP, Backup Override

Following from the example in Section 5.1.2, ASP1 withdraws from service:

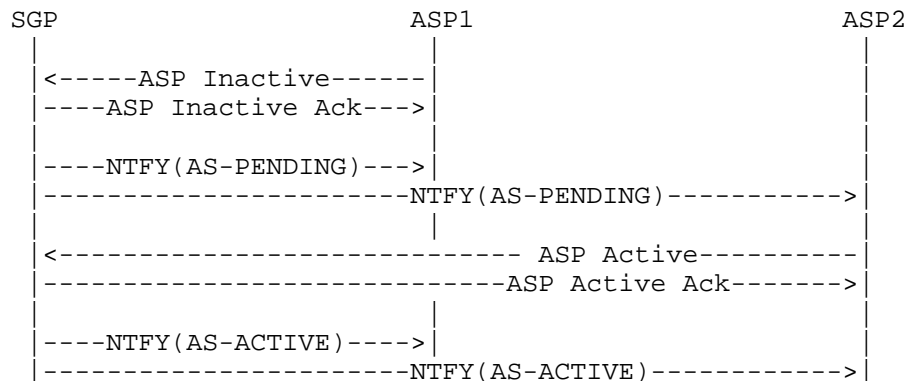

Note: If the SGP M3UA layer detects the loss of the M3UA peer (e.g., M3UA heartbeat loss or detection of SCTP failure), the initial ASP Inactive message exchange (i.e., SGP to ASP1) would not occur.

5.2.2. 1+1 Sparing, Backup Override

Following on from the example in Section 5.1.2, ASP2 wishes to Override ASP1 and take over the traffic:

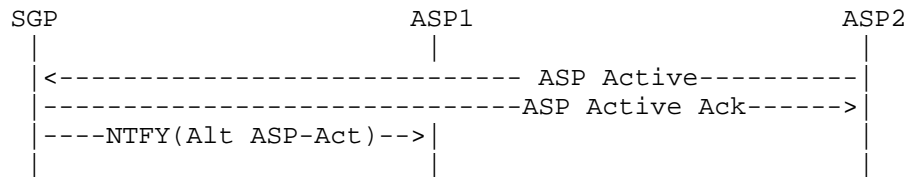

5.2.3. n+k Sparing, Loadsharing Case, Withdrawal of ASP

Following from the example in Section 5.1.4, ASP1 withdraws from service:

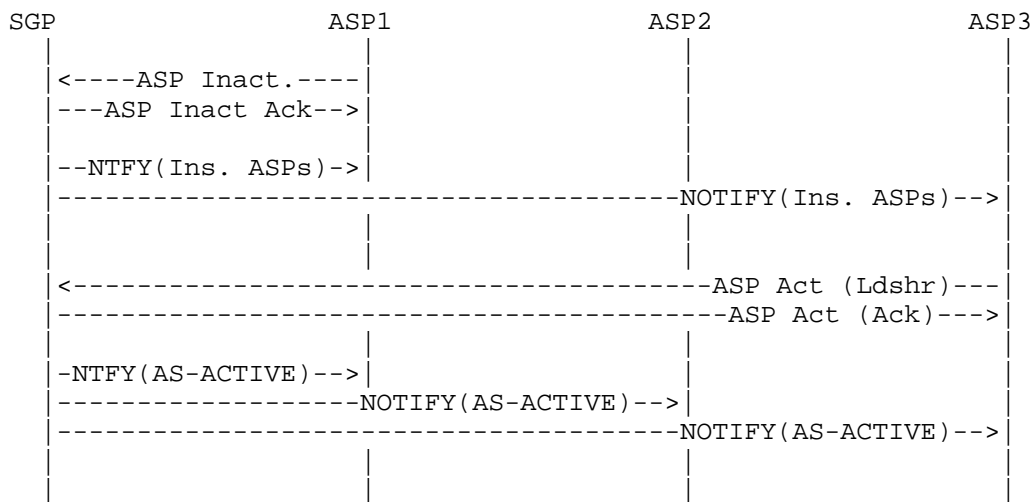

For the Notify message to be sent, the SG maintains knowledge of the minimum ASP resources required (e.g., if the SG knows that "n+k" = "2+1" for a Loadshare AS and "n" currently equals "1").

Note: If the SGP detects loss of the ASP1 M3UA peer (e.g., M3UA heartbeat loss or detection of SCTP failure), the initial ASP Inactive message exchange (i.e., SGP-ASP1) would not occur.

5.3. Normal Withdrawal of an ASP from an Application Server and Teardown of an Association

An ASP that is now confirmed in the state ASP-INACTIVE (i.e., the ASP has received an ASP Inactive Ack message) may now proceed to the ASP-DOWN state, if it is to be removed from service. Following from Section 5.2.1 or 5.2.3, where ASP1 has moved to the "Inactive" state:

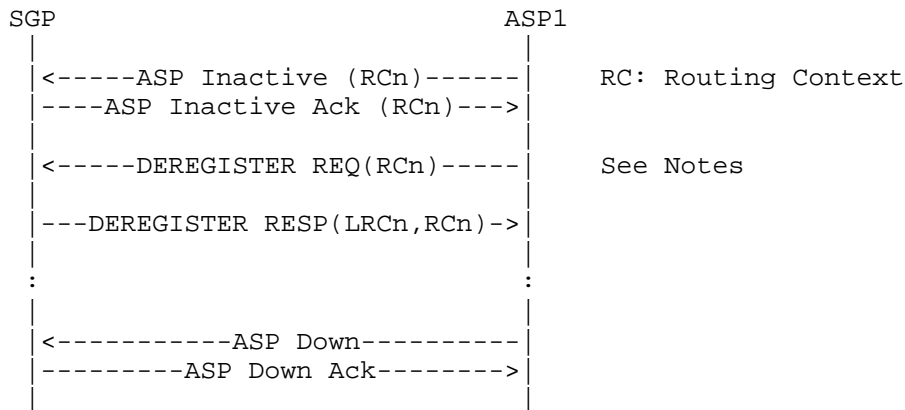

Note: The Deregistration procedure will typically be used if the ASP previously used the Registration procedures for configuration within the Application Server. ASP Inactive and Deregister messages exchanges may contain multiple Routing Contexts.

The ASP should be in the ASP-INACTIVE state and should have deregistered in all its Routing Contexts before attempting to move to the ASP-DOWN state.

5.4. Auditing Examples

5.4.1. SG State: Uncongested/Available

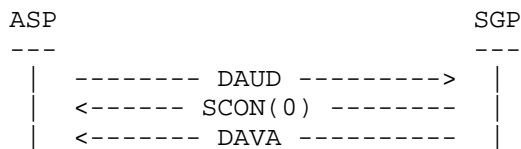

5.4.2. SG State: Congested (Congestion Level=2) / Available

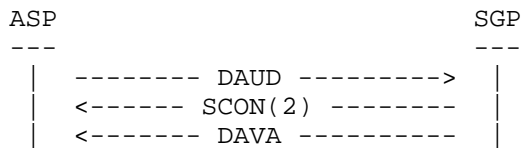

5.4.3. SG State: Unknown/Available

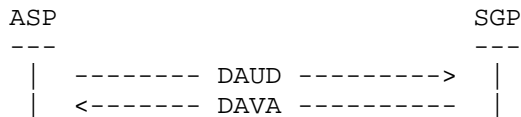

5.4.4. SG State: Unavailable

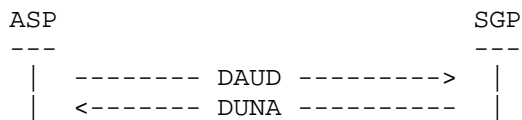

5.5. M3UA/MTP3-User Boundary Examples

5.5.1. At an ASP

This section describes the primitive mapping between the MTP3 User and the M3UA layer at an ASP.

5.5.1.1. Support for MTP-TRANSFER Primitives at the ASP

5.5.1.1.1. Support for MTP-TRANSFER Request Primitive

When the MTP3-User on the ASP has data to send to a remote MTP3-User, it uses the MTP-TRANSFER request primitive. The M3UA layer at the ASP will do the following when it receives an MTP-TRANSFER request primitive from the M3UA user:

- Determine the correct SGP.
- Determine the correct association to the chosen SGP.
- Determine the correct stream in the association (e.g., based on SLS).
- Determine whether to complete the optional fields of the DATA message.
- Map the MTP-TRANSFER request primitive into the Protocol Data field of a DATA message.
- Send the DATA message to the remote M3UA peer at the SGP, over the SCTP association.

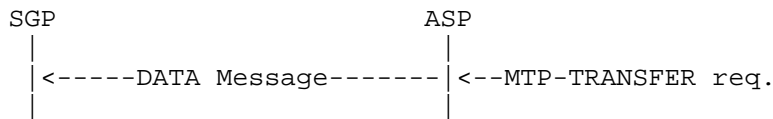

5.5.1.1.2. Support for the MTP-TRANSFER Indication Primitive

When the M3UA layer on the ASP receives a DATA message from the M3UA peer at the remote SGP, it will do the following:

- Evaluate the optional fields of the DATA message, if present.
- Map the Protocol Data field of a DATA message into the MTP-TRANSFER indication primitive.
- Pass the MTP-TRANSFER indication primitive to the user part. In case of multiple user parts, the optional fields of the Data message are used to determine the concerned user part.

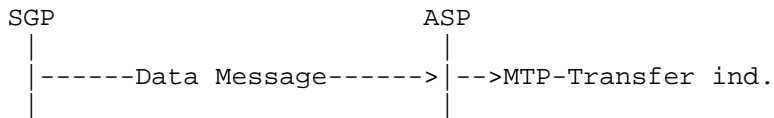

5.5.1.1.3. Support for ASP Querying of SS7 Destination States

There are situations such as temporary loss of connectivity to the SGP that may cause the M3UA layer at the ASP to audit SS7 destination availability/congestion states. Note: there is no primitive for the MTP3-User to request this audit from the M3UA layer, as this is initiated by an internal M3UA management function.

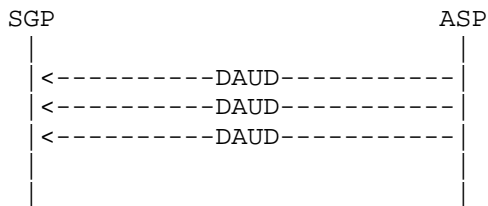

5.5.2. At an SGP

This section describes the primitive mapping between the MTP3-User and the M3UA layer at an SGP.

5.5.2.1. Support for MTP-TRANSFER Request Primitive at the SGP

When the M3UA layer at the SGP has received DATA messages from its peer destined to the SS7 network, it will do the following:

- Evaluate the optional fields of the DATA message, if present, to determine the Network Appearance.
- Map the Protocol data field of the DATA message into an MTP-TRANSFER request primitive.
- Pass the MTP-TRANSFER request primitive to the MTP3 of the concerned Network Appearance.

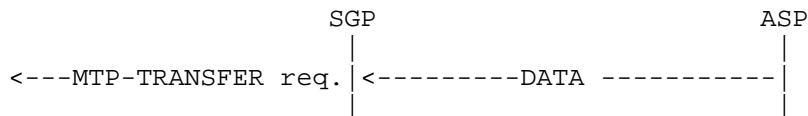

5.5.2.2. Support for MTP-TRANSFER Indication Primitive at the SGP

When the MTP3 layer at the SGP has data to pass its user parts, it will use the MTP-TRANSFER indication primitive. The M3UA layer at the SGP will do the following when it receives an MTP-TRANSFER indication primitive:

- Determine the correct AS, using the distribution function;
- Select an ASP in the ASP-ACTIVE state.
- Determine the correct association to the chosen ASP.
- Determine the correct stream in the SCTP association (e.g., based on SLS).
- Determine whether to complete the optional fields of the DATA message.
- Map the MTP-TRANSFER indication primitive into the Protocol Data field of a DATA message.
- Send the DATA message to the remote M3UA peer in the ASP, over the SCTP association.

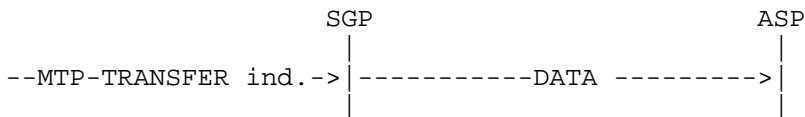

5.5.2.3. Support for MTP-PAUSE, MTP-RESUME, MTP-STATUS Indication Primitives

The MTP-PAUSE, MTP-RESUME, and MTP-STATUS indication primitives from the MTP3 upper layer interface at the SGP need to be made available to the remote MTP3 User Part lower-layer interface at the concerned ASP(s).

5.5.2.3.1. Destination Unavailable

The MTP3 layer at the SGP will generate an MTP-PAUSE indication primitive when it determines locally that an SS7 destination is unreachable. The M3UA layer will map this primitive to a DUNA

message. The SGP M3UA layer determines the set of concerned ASPs to be informed based on internal SS7 network information associated with the MTP-PAUSE indication primitive indication.

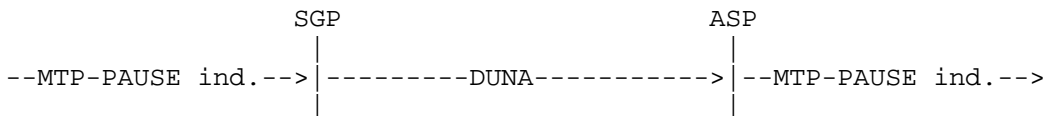

5.5.2.3.2. Destination Available

The MTP3 at the SGP will generate an MTP-RESUME indication primitive when it determines locally that an SS7 destination that was previously unreachable is now reachable. The M3UA layer will map this primitive to a DAVA message. The SGP M3UA determines the set of concerned ASPs to be informed based on internal SS7 network information associated with the MTP-RESUME indication primitive.

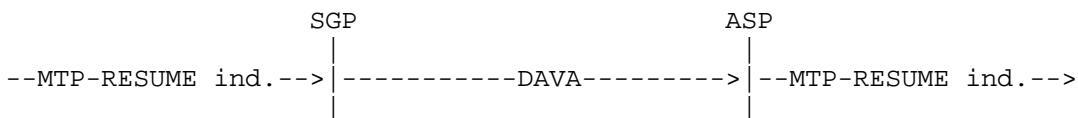

5.5.2.3.3. SS7 Network Congestion

The MTP3 layer at the SGP will generate an MTP-STATUS indication primitive when it determines locally that the route to an SS7 destination is congested. The M3UA layer will map this primitive to a SCON message. It will determine which ASP(s) to send the SCON message to, based on the intended Application Server.

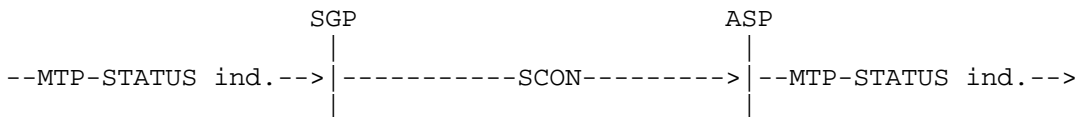

5.5.2.3.4. Destination User Part Unavailable

The MTP3 layer at the SGP will generate an MTP-STATUS indication primitive when it receives an UPU message from the SS7 network. The M3UA layer will map this primitive to a DUPU message. It will determine which ASP(s) to send the DUPU to based on the intended Application Server.

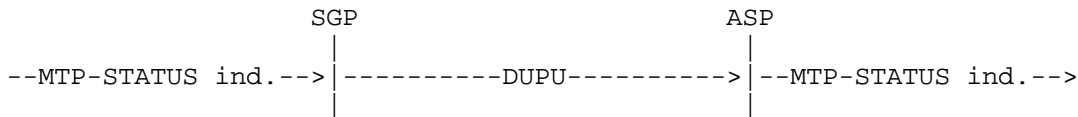

5.6. Examples for IPSP Communication

These scenarios show a basic example for IPSP communication for the three phases of the connection (establishment, data exchange, disconnection). It is assumed that the SCTP association is already set up. Both single exchange and double exchange behavior are included for illustrative purposes.

5.6.1. Single Exchange

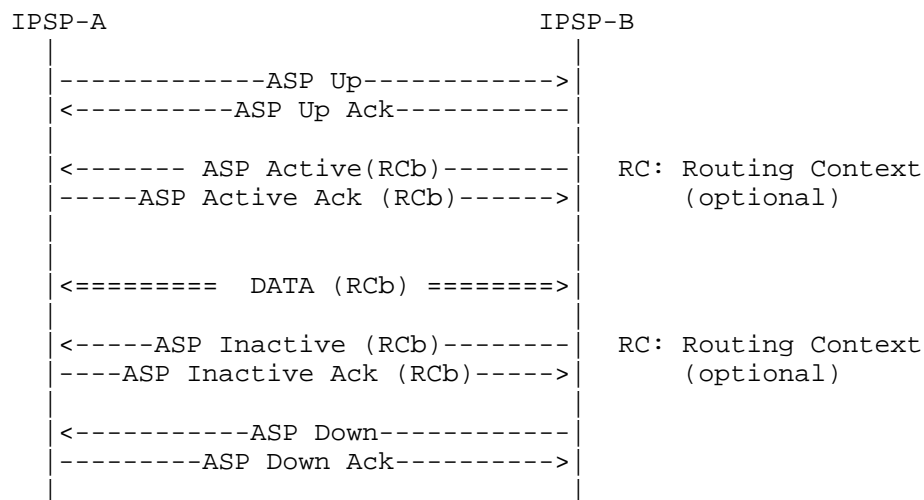

Routing Context is previously agreed to be the same in both directions.

5.6.2. Double Exchange

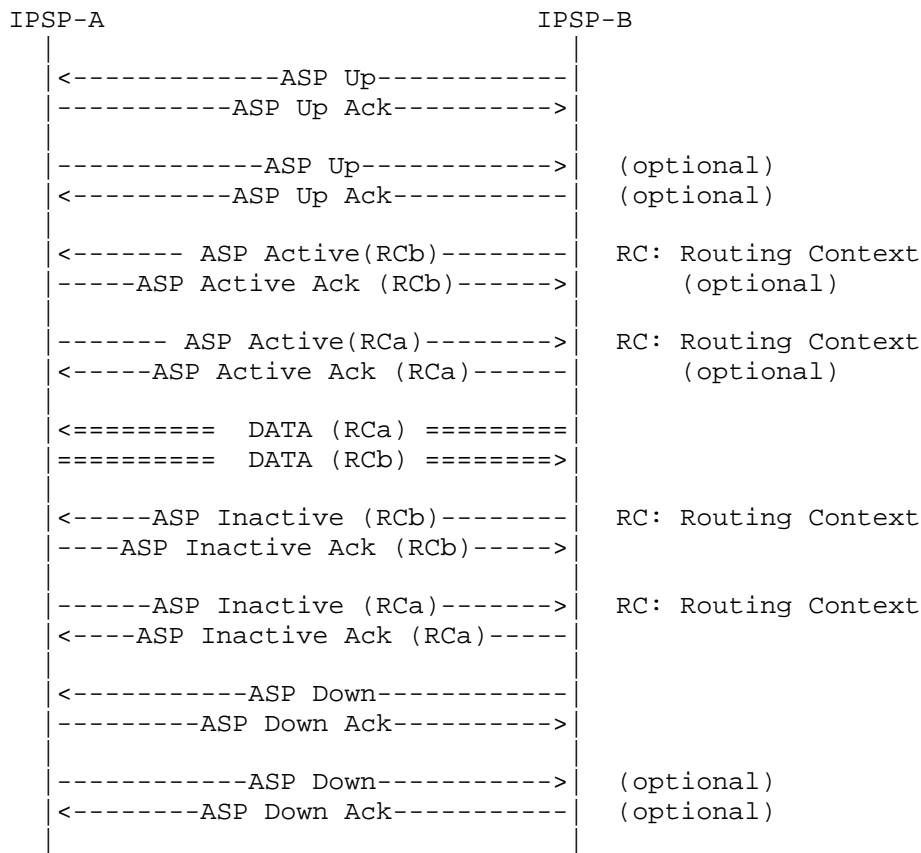

In this approach, only one single exchange of ASP Up message can be considered sufficient since the response by the other peer can be considered a notice that it is in ASP_UP state.

For the same reason, only one ASP Down message is needed, since once an IPSP receives ASP_Down ack message it is itself considered to be in the ASP_Down state and not allowed to receive ASPSM messages.

6. Security Considerations

Implementations MUST follow the normative guidance of RFC3788 [11] on the integration and usage of security mechanisms in SIGTRAN protocols.

7. IANA Considerations

This document contains no new actions for IANA. The subsections below are retained for historical purposes.

7.1. SCTP Payload Protocol Identifier

IANA has assigned an M3UA value for the Payload Protocol Identifier in the SCTP DATA chunk. The following SCTP Payload Protocol Identifier has been registered:

M3UA "3"

The SCTP Payload Protocol Identifier value "3" SHOULD be included in each SCTP DATA chunk, to indicate that the SCTP is carrying the M3UA protocol. The value "0" (unspecified) is also allowed but any other values MUST not be used. This Payload Protocol Identifier is not directly used by SCTP but MAY be used by certain network entities to identify the type of information being carried in a DATA chunk.

The User Adaptation peer MAY use the Payload Protocol Identifier as a way of determining additional information about the data being presented to it by SCTP.

7.2. M3UA Port Number

IANA has registered SCTP (and UDP/TCP) Port Number 2905 for M3UA. It is recommended that SGPs use this SCTP port number for listening for new connections. SGPs MAY also use statically configured SCTP port numbers instead.

7.3. M3UA Protocol Extensions

This protocol may also be extended through IANA in three ways:

- Through definition of additional message classes.
- Through definition of additional message types.
- Through definition of additional message parameters.

The definition and use of new message classes, types, and parameters is an integral part of SIGTRAN adaptation layers. Thus, these extensions are assigned by IANA through an IETF Consensus action as defined in Guidelines for Writing an IANA Considerations Section in RFCs [23].

The proposed extension must in no way adversely affect the general working of the protocol.

7.3.1. IETF-Defined Message Classes

The documentation for a new message class MUST include the following information:

- (a) A long and short name for the new message class.
- (b) A detailed description of the purpose of the message class.

7.3.2. IETF Defined Message Types

The documentation for a new message type MUST include the following information:

- (a) A long and short name for the new message type.
- (b) A detailed description of the structure of the message.
- (c) A detailed definition and description of intended use for each field within the message.
- (d) A detailed procedural description of the use of the new message type within the operation of the protocol.
- (e) A detailed description of error conditions when receiving this message type.

When an implementation receives a message type that it does not support, it MUST respond with an Error (ERR) message ("Unsupported Message Type").

7.3.3. IETF-Defined Parameter Extension

Documentation of the message parameter MUST contain the following information:

- (a) Name of the parameter type.
- (b) Detailed description of the structure of the parameter field. This structure MUST conform to the general type-length-value format described in Section 3.2.
- (c) Detailed definition of each component of the parameter value.
- (d) Detailed description of the intended use of this parameter type, and an indication of whether and under what circumstances multiple instances of this parameter type may be found within the same message.

8. Acknowledgements

The authors would like to thank Antonio Roque Alvarez, Joyce Archibald, Tolga Asveren, Maria-Cruz Bartolome-Rodrigo, Dan Brendes, Antonio Canete, Nikhil Jain, Roland Jesske, Joe Keller, Kurt Kite, Ming Lin, Steve Lorusso, Naoto Makinae, Howard May, Francois Mouillaud, Barry Nagelberg, Neil Olson, Heinz Prantner, Shyamal

Prasad, Mukesh Punhani, Selvam Rengasami, John Schantz, Ray Singh, Michael Tuexen, Nitin Tomar, Gery Verwimp, Tim Vetter, Kazuo Watanabe, Ben Wilson, and many others for their valuable comments and suggestions.

9. Document Contributors

Ian Rytina - Ericsson
Guy Mousseau - Nortel Networks
Lyndon Ong - Ciena
Hanns Juergen Schwarzbauer - Siemens
Klaus Gradischnig - Detecon Inc.
Malleesh Kalla - Telcordia
Normand Glaude - Performance Technologies
Brian Bidulock - OpenSS7
John Loughney - Nokia
Greg Sidebottom - Signatus Technologies

10. References

10.1. Normative References

- [1] ITU-T Recommendations Q.761 to Q.767, "Signalling System No.7 (SS7) - ISDN User Part (ISUP)"
- [2] ANSI T1.113 - "Signaling System Number 7 - ISDN User Part"
- [3] ETSI ETS 300 356-1 "Integrated Services Digital Network (ISDN); Signalling System No.7; ISDN User Part (ISUP) version 2 for the international interface; Part 1: Basic services"
- [4] ITU-T Recommendations Q.711 to Q.715, "Signalling System No. 7 (SS7) - Signalling Connection Control Part (SCCP)"
- [5] ANSI T1.112 "Signaling System Number 7 - Signaling Connection Control Part"
- [6] ETSI ETS 300 009-1, "Integrated Services Digital Network (ISDN); Signalling System No.7; Signalling Connection Control Part (SCCP) (connectionless and connection-oriented class 2) to support international interconnection; Part 1: Protocol specification"
- [7] ITU-T Recommendations Q.700 to Q.705, "Signalling System No. 7 (SS7) - Message Transfer Part (MTP)"
- [8] ANSI T1.111 "Signaling System Number 7 - Message Transfer Part"

- [9] ETSI ETS 300 008-1, "Integrated Services Digital Network (ISDN); Signalling System No.7; Message Transfer Part (MTP) to support international interconnection; Part 1: Protocol specification"
- [10] Yergeau, F., "UTF-8, a transformation format of ISO 10646", STD 63, RFC 3629, November 2003.
- [11] Loughney, J., Tuexen, M., and J. Pastor-Balbas, "Security Considerations for Signaling Transport (SIGTRAN) Protocols", RFC 3788, June 2004.

10.2. Informative References

- [12] Ong, L., Rytina, I., Garcia, M., Schwarzbauer, H., Coene, L., Lin, H., Juhasz, I., Holdrege, M., and C. Sharp, "Framework Architecture for Signaling Transport", RFC 2719, October 1999.
- [13] ITU-T Recommendation Q.720, "Telephone User Part"
- [14] ITU-T Recommendations Q.771 to Q.775 "Signalling System No. 7 (SS7) - Transaction Capabilities (TCAP)"
- [15] ANSI T1.114 "Signaling System Number 7 - Transaction Capabilities Application Part"
- [16] ETSI ETS 300 287-1, "Integrated Services Digital Network (ISDN); Signalling System No.7; Transaction Capabilities (TC) version 2; Part 1: Protocol specification"
- [17] 3G TS 25.410 V4.0.0 (2001-04) "Technical Specification - 3rd Generation partnership Project; Technical Specification Group Radio Access Network; UTRAN Iu Interface: General Aspects and Principles"
- [18] Stewart, R., Xie, Q., Morneault, K., Sharp, C., Schwarzbauer, H., Taylor, T., Rytina, I., Kalla, M., Zhang, L., and V. Paxson, "Stream Control Transmission Protocol", RFC 2960, October 2000.
- [19] ITU-T Recommendation Q.2140 "B-ISDN ATM Adaptation Layer - Service Specific Coordination Function for signalling at the Network Node Interface (SSCF at NNI)"
- [20] ITU-T Recommendation Q.2110 "B-ISDN ATM Adaptation Layer - Service Specific Connection Oriented Protocol (SSCOP)"
- [21] Bradner, S., "Key words for use in RFCs to Indicate Requirement Levels", BCP 14, RFC 2119, March 1997.

- [22] ITU-T Recommendation Q.2210 "Message Transfer Part Level 3 functions and messages using the services of ITU Recommendation Q.2140"
- [23] Narten, T. and H. Alvestrand, "Guidelines for Writing an IANA Considerations Section in RFCs", BCP 26, RFC 2434, October 1998.
- [24] Morneault, K., Dantu, R., Sidebottom, G., Bidulock, B., and J. Heitz, "Signaling System 7 (SS7) Message Transfer Part 2 (MTP2) - User Adaptation Layer", RFC 3331, September 2002.
- [25] George, T., Bidulock, B., Dantu, R., Schwarzbauer, H., and K. Morneault, "Signaling System 7 (SS7) Message Transfer Part 2 (MTP2) - User Peer-to-Peer Adaptation Layer (M2PA)", RFC 4165, September 2005.
- [26] Telecommunication Technology Committee (TTC) Standard JT-Q704, "Message Transfer Part Signaling Network Functions", April 28, 1992.

Appendix A

A.1. Signalling Network Architecture

A Signalling Gateway is used to support the transport of MTP3-User signalling traffic received from the SS7 network to multiple distributed ASPs (e.g., MGCs and IP Databases). Clearly, the M3UA protocol is not designed to meet the performance and reliability requirements for such transport by itself. However, the conjunction of distributed architecture and redundant networks provides support for reliable transport of signalling traffic over IP. The M3UA protocol is flexible enough to allow its operation and management in a variety of physical configurations, enabling Network Operators to meet their performance and reliability requirements.

To meet the stringent SS7 signalling reliability and performance requirements for carrier grade networks, Network Operators might require that no single point of failure is present in the end-to-end network architecture between an SS7 node and an IP-based application. This can typically be achieved through the use of redundant SGPs or SGs, redundant hosts, and the provision of redundant QOS-bounded IP network paths for SCTP Associations between SCTP End Points. Obviously, the reliability of the SG, the MGC, and other IP-based functional elements also needs to be taken into account. The distribution of ASPs and SGPs within the available Hosts MAY also be considered. As an example, for a particular Application Server, the related ASPs could be distributed over at least two Hosts.

One example of a physical network architecture relevant to SS7 carrier grade operation in the IP network domain is shown in Figure A-1, below:

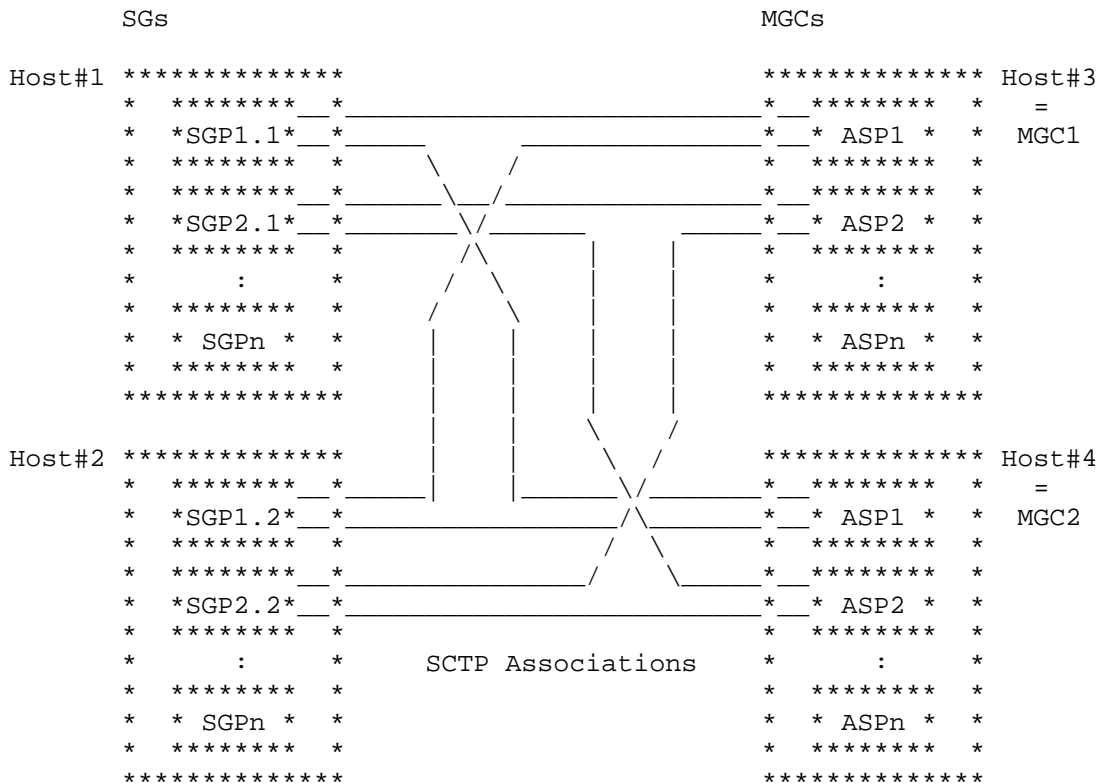

SGP1.1 and SGP1.2 are part of SG1
SGP2.1 and SGP2.2 are part of SG2

Figure A-1 - Physical Model

In this model, each host may have many application processes. In the case of the MGC, an ASP may provide service to one or more Application Servers, and is identified as an Sctp end point. One or more Signalling Gateway Processes make up a single Signalling Gateway.

This example model can also be applied to IPSP-IPSP signalling. In this case, each IPSP may have its services distributed across 2 or more hosts, and may have multiple server processes on each host.

In the example above, each signalling process (SGP, ASP, or IPSP) is the end point to more than one Sctp association, leading to more than one other signalling processes. To support this, a signalling process must be able to support distribution of M3UA messages to many simultaneous active associations. This message distribution function

is based on the status of provisioned Routing Keys, the status of the signalling routes to signalling points in the SS7 network, and the redundancy model (active-standby, load sharing, broadcast, n+k) of the remote signalling processes.

For carrier grade networks, the failure or isolation of a particular signalling process should not cause stable calls or transactions to be lost. This implies that signalling processes need, in some cases, to share the call/transaction state or be able to pass the call state information between each other. In the case of ASPs performing call processing, coordination may also be required with the related Media Gateway to transfer the MGC control for a particular trunk termination. However, this sharing or communication of call/transaction state information is outside the scope of this document.

This model serves as an example. M3UA imposes no restrictions as to the exact layout of the network elements, the message distribution algorithms, and the distribution of the signalling processes. Instead, it provides a framework and a set of messages that allow for a flexible and scalable signalling network architecture, aiming to provide reliability and performance.

A.2. Redundancy Models

A.2.1. Application Server Redundancy

At the SGP, an Application Server list contains active and inactive ASPs to support ASP broadcast, loadsharing, and failover procedures. The list of ASPs within a logical Application Server is kept updated in the SGP to reflect the active Application Server Process(es).

For example, in the network shown in Figure 1, all messages to DPC x could be sent to ASP1 in Host3 or ASP1 in Host4. The AS list at SGP1 in Host 1 might look like the following:

```
Routing Key {DPC=x} - "Application Server #1"  
  ASP1/Host3 - State = Active  
  ASP1/Host4 - State = Inactive
```

In this "1+1" redundancy case, ASP1 in Host3 would be sent any incoming message with DPC=x. ASP1 in Host4 would normally be brought to the "active" state upon failure of, or loss of connectivity to, ASP1/Host1.

The AS List at SGP1 in Host1 might also be set up in loadshare mode:

```
Routing Key {DPC=x) - "Application Server #1"  
  ASP1/Host3 - State = Active  
  ASP1/Host4 - State = Active
```

In this case, both the ASPs would be sent a portion of the traffic. For example, the two ASPs could together form a database, where incoming queries may be sent to any active ASP.

Care might need to be exercised by a Network Operator in the selection of the routing information to be used as the Routing Key for a particular AS.

In the process of failover, it is recommended that, in the case of ASPs supporting call processing, stable calls do not fail. It is possible that calls in "transition" may fail, although measures of communication between the ASPs involved can be used to mitigate this.

For example, the two ASPs may share call state via shared memory, or may use an ASP to ASP protocol to pass call state information. Any ASP-to-ASP protocol to support this function is outside the scope of this document.

A.2.2. Signalling Gateway Redundancy

Signalling Gateways may also be distributed over multiple hosts. Much like the AS model, SGs may comprise one or more SG Processes (SGPs), distributed over one or more hosts, using an active/backup or a loadsharing model. Should an SGP lose all or partial SS7 connectivity and other SGPs exist, the SGP may terminate the SCTP associations to the concerned ASPs.

It is therefore possible for an ASP to route signalling messages destined to the SS7 network using more than one SGP. In this model, a Signalling Gateway is deployed as a cluster of hosts acting as a single SG. A primary/backup redundancy model is possible, where the unavailability of the SCTP association to a primary SGP could be used to reroute affected traffic to an alternate SGP. A loadsharing model is possible, where the signalling messages are loadshared between multiple SGPs. A broadcast model is also possible, where signalling messages are sent to each active SGP in the SG. The distribution of the MTP3-user messages over the SGPs should be done in such a way to minimize message missequencing, as required by the SS7 User Parts.

It may also be possible for an ASP to use more than one SG to access a specific SS7 end point, in a model that resembles an SS7 STP mated pair. Typically, SS7 STPs are deployed in mated pairs, with traffic loadshared between them. Other models are also possible, subject to the limitations of the local SS7 network provisioning guidelines.

From the perspective of the M3UA layer at an ASP, a particular SG is capable of transferring traffic to a provisioned SS7 destination X if an SCTP association with at least one SGP of the SG is established, the SGP has returned an acknowledgement to the ASP to indicate that the ASP is actively handling traffic for that destination X, the SGP has not indicated that the destination X is inaccessible, and the SGP has not indicated MTP Restart. When an ASP is configured to use multiple SGPs for transferring traffic to the SS7 network, the ASP must maintain knowledge of the current capability of the SGPs to handle traffic to destinations of interest. This information is crucial to the overall reliability of the service, for active/backup, loadsharing, and broadcast models, in the event of failures and recovery and maintenance activities. The ASP M3UA may also use this information for congestion avoidance purposes. The distribution of the MTP3-user messages over the SGPs should be done in such a way as to minimize message missequencing, as required by the SS7 User Parts.

Editors' Addresses

Ken Morneault
Cisco Systems Inc.
13615 Dulles Technology Drive
Herndon, VA, USA 20171

EMail: kmorneau@cisco.com

Javier Pastor-Balbas
Ericsson Espana S.A.
C/ Retama 1
28045 Madrid - Spain

EMail: j.javier.pastor@ericsson.com

Full Copyright Statement

Copyright (C) The Internet Society (2006).

This document is subject to the rights, licenses and restrictions contained in BCP 78, and except as set forth therein, the authors retain all their rights.

This document and the information contained herein are provided on an "AS IS" basis and THE CONTRIBUTOR, THE ORGANIZATION HE/SHE REPRESENTS OR IS SPONSORED BY (IF ANY), THE INTERNET SOCIETY AND THE INTERNET ENGINEERING TASK FORCE DISCLAIM ALL WARRANTIES, EXPRESS OR IMPLIED, INCLUDING BUT NOT LIMITED TO ANY WARRANTY THAT THE USE OF THE INFORMATION HEREIN WILL NOT INFRINGE ANY RIGHTS OR ANY IMPLIED WARRANTIES OF MERCHANTABILITY OR FITNESS FOR A PARTICULAR PURPOSE.

Intellectual Property

The IETF takes no position regarding the validity or scope of any Intellectual Property Rights or other rights that might be claimed to pertain to the implementation or use of the technology described in this document or the extent to which any license under such rights might or might not be available; nor does it represent that it has made any independent effort to identify any such rights. Information on the procedures with respect to rights in RFC documents can be found in BCP 78 and BCP 79.

Copies of IPR disclosures made to the IETF Secretariat and any assurances of licenses to be made available, or the result of an attempt made to obtain a general license or permission for the use of such proprietary rights by implementers or users of this specification can be obtained from the IETF on-line IPR repository at <http://www.ietf.org/ipr>.

The IETF invites any interested party to bring to its attention any copyrights, patents or patent applications, or other proprietary rights that may cover technology that may be required to implement this standard. Please address the information to the IETF at ietf-ipr@ietf.org.

Acknowledgement

Funding for the RFC Editor function is provided by the IETF Administrative Support Activity (IASA).